

MX269022A
LTE TDD Downlink Measurement
Software
Operation Manual
Operation

17th Edition

- For safety and warning information, please read this manual before attempting to use the equipment.
- Additional safety and warning information is provided within the MS2690A/MS2691A/MS2692A Signal Analyzer Operation Manual (Mainframe Operation) or MS2830A Signal Analyzer Operation Manual (Mainframe Operation). Please also refer to this document before using the equipment.
- Keep this manual with the equipment.

ANRITSU CORPORATION

Safety Symbols

To prevent the risk of personal injury or loss related to equipment malfunction, Anritsu Corporation uses the following safety symbols to indicate safety-related information. Ensure that you clearly understand the meanings of the symbols BEFORE using the equipment. Some or all of the following symbols may be used on all Anritsu equipment. In addition, there may be other labels attached to products that are not shown in the diagrams in this manual.

Symbols used in manual

 **DANGER** This indicates a very dangerous procedure that could result in serious injury or death if not performed properly.

 **WARNING** This indicates a hazardous procedure that could result in serious injury or death if not performed properly.

 **CAUTION** This indicates a hazardous procedure or danger that could result in light-to-severe injury, or loss related to equipment malfunction, if proper precautions are not taken.

Safety Symbols Used on Equipment and in Manual

The following safety symbols are used inside or on the equipment near operation locations to provide information about safety items and operation precautions. Ensure that you clearly understand the meanings of the symbols and take the necessary precautions BEFORE using the equipment.



This indicates a prohibited operation. The prohibited operation is indicated symbolically in or near the barred circle.



This indicates an obligatory safety precaution. The obligatory operation is indicated symbolically in or near the circle.



This indicates a warning or caution. The contents are indicated symbolically in or near the triangle.



This indicates a note. The contents are described in the box.



These indicate that the marked part should be recycled.

MX269022A
LTE TDD Downlink Measurement Software
Operation Manual Operation

15 May 2009 (First Edition)
23 June 2016 (17th Edition)

Copyright © 2009-2016, ANRITSU CORPORATION.

All rights reserved. No part of this manual may be reproduced without the prior written permission of the publisher.

The contents of this manual may be changed without prior notice.

Printed in Japan

Equipment Certificate

Anritsu Corporation guarantees that this equipment was inspected at shipment and meets the published specifications.

Anritsu Warranty

- During the warranty period, Anritsu Corporation will repair or exchange this software free-of-charge if it proves defective when used as described in the operation manual.
- The warranty period is 6 months from the purchase date.
- The warranty period after repair or exchange will remain 6 months from the original purchase date, or 30 days from the date of repair or exchange, depending on whichever is longer.
- This warranty does not cover damage to this software caused by Acts of God, natural disasters, and misuse or mishandling by the customer.

In addition, this warranty is valid only for the original equipment purchaser. It is not transferable if the equipment is resold.

Anritsu Corporation shall assume no liability for injury or financial loss of the customer due to the use of or a failure to be able to use this equipment.

Anritsu Corporation Contact

In the event that this equipment malfunctions, contact an Anritsu Service and Sales office. Contact information can be found on the last page of the printed version of this manual, and is available in a separate file on the CD version.

Notes On Export Management

This product and its manuals may require an Export License/Approval by the Government of the product's country of origin for re-export from your country.

Before re-exporting the product or manuals, please contact us to confirm whether they are export-controlled items or not.

When you dispose of export-controlled items, the products/manuals need to be broken/shredded so as not to be unlawfully used for military purpose.

Software End-User License Agreement (EULA)

Please read this Software End-User License Agreement (hereafter this EULA) carefully before using (includes executing, copying, registering, etc.) this software (includes programs, databases, scenarios, etc., used to operate, set, etc., Anritsu electronic equipment). By reading this EULA and using this software, you are agreeing to be bound by the terms of its contents and Anritsu Corporation (hereafter Anritsu) hereby grants you the right to use this Software with the Anritsu-specified equipment (hereafter Equipment) for the purposes set out in this EULA.

1. Grant of License and Limitations

1. Regardless of whether this Software was purchased from or provided free-of-charge by Anritsu, you agree not to rent, lease, lend, or otherwise distribute this Software to third parties and further agree not to disassemble, recompile, reverse engineer, modify, or create derivative works of this Software.
2. You may make one copy of this Software for backup purposes only.
3. You are not permitted to reverse engineer this software.
4. This EULA allows you to install one copy of this Software on one piece of Equipment.

2. Disclaimers

To the extent not prohibited by law, in no event shall Anritsu be liable for personal injury, or any incidental, special, indirect or consequential damages whatsoever, including, without limitation, damages for loss of profits, loss of data, business interruption or any other commercial damages or losses, arising out of or related to your use or inability to use this Software.

3. Limitation of Liability

- a. If a fault (bug) is discovered in this Software, preventing operation as described in the operation manual or specifications whether or not the customer uses this software as described in the manual, Anritsu shall at its own discretion, fix the bug, or exchange the software, or suggest a workaround, free-of-charge. However, notwithstanding the above, the following items shall be excluded from repair and warranty.
 - i) If this Software is deemed to be used for purposes not described in the operation manual or specifications.
 - ii) If this Software is used in conjunction with other non-Anritsu-approved software.
 - iii) Recovery of lost or damaged data.
 - iv) If this Software or the Equipment has been modified, repaired, or otherwise altered without Anritsu's prior approval.
 - v) For any other reasons out of Anritsu's direct control and responsibility, such as but not limited to, natural disasters, software virus infections, etc.
- b. Expenses incurred for transport, hotel, daily allowance, etc., for on-site repairs by Anritsu engineers necessitated by the above faults shall be borne by you.
- c. The warranty period for faults listed in article 3a above covered by this EULA shall be either 6 months from the date of purchase of this Software or 30 days after the date of repair, whichever is longer.

4. Export Restrictions

You may not use or otherwise export or re-export directly or indirectly this Software except as authorized by Japanese and United States law. In particular, this software may not be exported or re-exported (a) into any Japanese or US embargoed countries or (b) to anyone on the Japanese or US Treasury Department's list of Specially Designated Nationals or the US Department of Commerce Denied Persons List or Entity List. By using this Software, you warrant that you are not located in any such country or on any such list. You also agree that you will not use this Software for any purposes prohibited by Japanese and US law, including, without limitation, the development, design and manufacture or production of missiles or nuclear, chemical or biological weapons of mass destruction.

5. Termination

Anritsu shall deem this EULA terminated if you violate any conditions described herein. This EULA shall also be terminated if the conditions herein cannot be continued for any good reason, such as violation of copyrights, patents, or other laws and ordinances.

6. Reparations

If Anritsu suffers any loss, financial or otherwise, due to your violation of the terms of this EULA, Anritsu shall have the right to seek proportional damages from you.

7. Responsibility after Termination

Upon termination of this EULA in accordance with item 5, you shall cease all use of this Software immediately and shall as directed by Anritsu either destroy or return this Software and any backup copies, full or partial, to Anritsu.

8. Dispute Resolution

If matters of dispute or items not covered by this EULA arise, they shall be resolved by negotiations in good faith between you and Anritsu.

9. Court of Jurisdiction

This EULA shall be interpreted in accordance with Japanese law and any disputes that cannot be resolved by negotiation described in Article 8 shall be settled by the Japanese courts.

Cautions against computer virus infection

- Copying files and data
Only files that have been provided directly from Anritsu or generated using Anritsu equipment should be copied to the instrument.
All other required files should be transferred by means of USB or CompactFlash media after undergoing a thorough virus check.
- Adding software
Do not download or install software that has not been specifically recommended or licensed by Anritsu.
- Network connections
Ensure that the network has sufficient anti-virus security protection in place.

CE Conformity Marking

Anritsu affixes the CE conformity marking on the following product(s) in accordance with the Decision 768/2008/EC to indicate that they conform to the EMC and LVD directive of the European Union (EU).

CE marking



1. Product Model

Software: MX269022A LTE TDD Downlink Measurement Software

2. Applied Directive and Standards

When the MX269022A LTE TDD Downlink Measurement Software is installed in the MS2690A/MS2691A/MS2692A or MS2830A, the applied directive and standards of this unit conform to those of the MS2690A/MS2691A/MS2692A or MS2830A main frame.

PS: About main frame

Please contact Anritsu for the latest information on the main frame types that the MX269022A can be used with.

RCM Conformity Marking

Anritsu affixes the RCM mark on the following product(s) in accordance with the regulation to indicate that they conform to the EMC framework of Australia/New Zealand.

RCM marking



1. Product Model

Software: MX269022A LTE TDD Downlink Measurement Software

2. Applied Directive and Standards

When the MX269022A LTE TDD Downlink Measurement Software is installed in the MS2690A/MS2691A/MS2692A or MS2830A, the applied directive and standards of this unit conform to those of the MS2690A/MS2691A/MS2692A or MS2830A main frame.

PS: About main frame

Please contact Anritsu for the latest information on the main frame types that the MX269022A can be used with.

About This Manual

■ Composition of Operation Manuals

The operation manuals for the MX269022A LTE TDD Downlink Measurement Software are comprised as shown in the figure below.

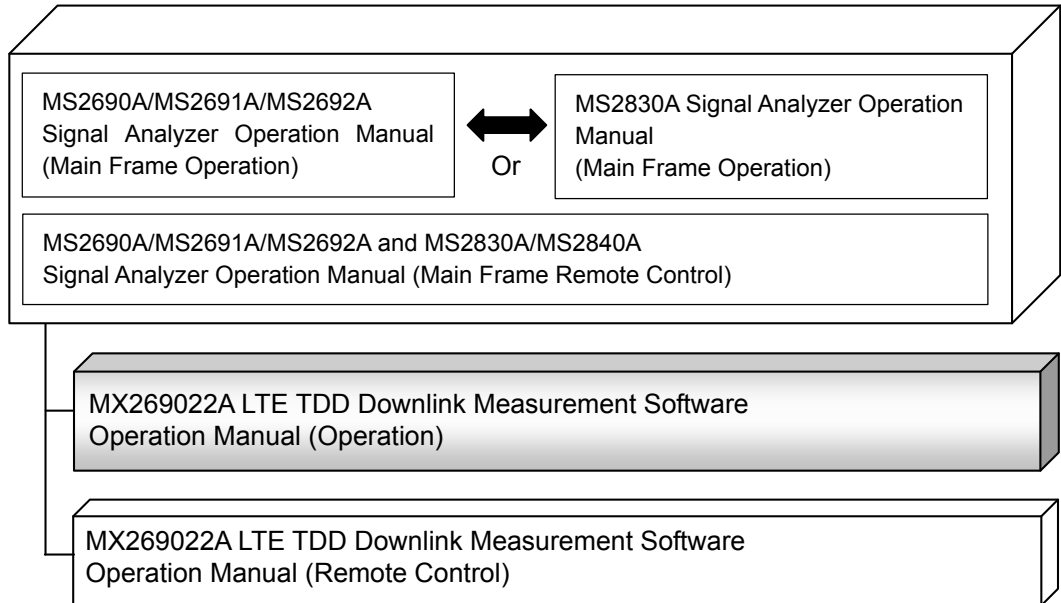

- Signal Analyzer Operation Manual (Mainframe Operation)
- Signal Analyzer Operation Manual (Mainframe Remote Control)

These manuals describe basic operating methods, maintenance procedures, common functions, and common remote control of the signal analyzer mainframe.

- LTE TDD Downlink Measurement Software Operation Manual (Operation) <This document>

This manual describes basic operating methods, and functions of the LTE TDD Downlink Measurement Software. As for signal analyzer hardware and its basic functions and operation outline, refer to *MS2690A/MS2691A/MS2692A Signal Analyzer Operation Manual (Mainframe Operation)* or *MS2830A Signal Analyzer Operation Manual (Mainframe Operation)*.

- LTE TDD Downlink Measurement Software Operation Manual (Remote Control)

This manual describes remote control of the LTE TDD Downlink Measurement Software. As for signal analyzer application's basic remote control functions and its definitions of common commands, refer to *MS2690A/MS2691A/MS2692A and MS2830A/MS2840A Signal Analyzer Operation Manual (Mainframe Remote Control)*.

Convention Used in This Manual

Throughout this document, the use of MS269xA Series is assumed unless otherwise specified. If using MS2830A, change MS269xA to read MS2830A.

In this document,  indicates a panel key.

Table of Contents

About This Manual.....	I
Chapter 1 Overview.....	1-1
1.1 Product Overview	1-2
1.2 Product Configuration	1-3
1.3 Specifications.....	1-4
Chapter 2 Preparation.....	2-1
2.1 Part Names	2-2
2.2 Signal Path Setup	2-11
2.3 Application Startup and Selection.....	2-12
2.4 Initialization and Calibration.....	2-13
Chapter 3 Measurement	3-1
3.1 Basic Operation	3-6
3.2 Setting Frequency and Level	3-12
3.3 Setting Trigger	3-15
3.4 Common Settings	3-17
3.5 Setting Modulation Analysis.....	3-23
3.6 Modulation Analysis Measurement and Results.....	3-47
3.7 Power vs Time Setting.....	3-71
3.8 Measurement and Result for Power vs Time	3-84
3.9 MIMO Summary Settings.....	3-91
3.10 MIMO Summary Measurement Results	3-93
3.11 Setting Batch Measurement	3-95
3.12 Batch Measurement Results.....	3-131
3.13 Spectrum Measurement	3-134

1
2
3
4
5
6
Index

Chapter 4	Digitizing and Replaying	4-1
4.1	Digitize function.....	4-2
4.2	Replay Function.....	4-8
Chapter 5	Performance Test	5-1
5.1	Overview of Performance Test	5-2
5.2	Performance Test Items	5-3
Chapter 6	Other Functions	6-1
6.1	Selecting Other Functions	6-2
6.2	Setting Title	6-2
6.3	Erasing Warmup Message	6-2
Index		Index-1

Chapter 1 Overview

This chapter provides an overview of the MX269022A LTE TDD Measurement Software and describes the product configuration.

1.1	Product Overview	1-2
1.2	Product Configuration	1-3
1.2.1	Standard configuration	1-3
1.2.2	Option	1-3
1.2.3	Applicable parts	1-3
1.3	Specifications	1-4

1.1 Product Overview

MS269x Series or MS2830A Signal Analyzer enables high-speed, high-accuracy, and simple measurements of transmission characteristics of base stations and mobile stations for various mobile communications types. The MS2690A/MS2691A/MS2692A or MS2830A is equipped with high-performance signal analyzer and spectrum analyzer functions as standard, with optional measurement software allowing modulation analysis functionality supporting various digital modulation modes.

The MX269022A LTE TDD Downlink Measurement Software (hereinafter referred to as MX269022A) is a software option for measuring the RF characteristics of LTE TDD (Frame structure type 2) downlink signal specified by 3GPP, TS36.211 V8.6.0 (2009-03) Physical Channels and Modulation (Release 8).

The MX269022A provides the following measurement features.

- Modulation accuracy measurement
- Carrier frequency measurement
- Transmitter power measurement

MS2830A-005/105 and MS2830A-006/106 is required to use the MX269022A on MS2830A.

1.2 Product Configuration

1.2.1 Standard configuration

Table 1.2.1-1 lists the standard configuration of the MX269022A.

Table 1.2.1-1 Standard configuration

Item	Model Name/Symbol	Product Name	Q'ty	Remarks
Application	MX269022A	LTE TDD Downlink Measurement Software	1	
Accessory	—	Installation CD-ROM	1	Application software, operation manual CD-ROM

1.2.2 Option

Tables 1.2.2-1 list the option for the MX269022A. This is sold separately.

Table 1.2.2-1 Option

Option No.	Product Name	Remarks
MX269022A-001	LTE-Advanced TDD Downlink Measurement Software	

1.2.3 Applicable parts

Table 1.2.3-1 lists the applicable parts for the MX269022A.

Table 1.2.3-1 Applicable parts

Model Name/Symbol	Product Name	Remarks
W3209AE	MX269022A LTE TDD Downlink Measurement Software Operation Manual (Operation)	English, printed version
W3210AE	MX269022A LTE TDD Downlink Measurement Software Operation Manual (Remote Control)	English, printed version

1.3 Specifications

Table 1.3-1 shows the specifications for the MX269022A.

When MS2830A is used, this software's specification is specified by the condition below, unless otherwise noted.

Attenuator Mode: Mechanical Atten Only

Table 1.3-1 Specifications

Item	Specification
Common Specifications	
Channel bandwidth	1.4, 3, 5, 10, 15, 20 MHz
Target signal	LTE TDD Downlink
Capture time	Capture Time = Auto : 5 frame Capture Time = Manual : 5 to 150 frame
Modulation/Frequency Measurement	
Measurement frequency ranges	MS269x Series: 600 to 4000 MHz MS2830A-041/043/044/045: 600 to 4000 MHz MS2830A-040: 600 to 3600 MHz
Measurement level range	-15 to +30 dBm (at Pre-Amp Off, or Pre-Amp not installed.) -30 to +10 dBm (at Pre-Amp On)
Carrier frequency accuracy	After CAL execution at 18 to 28°C For a signal of EVM = 1% When Downlink 10 Subframe is the measurement target MS269x series: ± (accuracy of reference frequency × carrier frequency + 3 Hz) (Excluding the Batch Measurement when MS269xA-004/104 is installed) MS2830A: ± (accuracy of reference frequency × carrier frequency + 3.5 Hz) (When the center frequency is from 600 MHz to 2700 MHz and MS2830A-078 is not installed) ± (accuracy of reference frequency × carrier frequency + 8.0 Hz) (When the center frequency is from 2700 MHz to 4000 MHz and MS2830A-078 is not installed) ± (accuracy of reference frequency × carrier frequency + 4.0 Hz) (In the CC of the center frequency when the center frequency is from 600 MHz to 2700 MHz and MS2830A-078 is installed) (At the input level of -4 dBm when MS2830A-045 is installed) ± (accuracy of reference frequency × carrier frequency + 8.0 Hz) (In the CC of the center frequency when the center frequency is from 2700 MHz to 4000 MHz and MS2830A-078 is installed) (And when MS2830A-045 is installed, at the input level of -4 dBm)

Table 1.3-1 Specifications (Cont'd)

Item	Specification
Residual EVM	<p>After CAL execution at 18 to 28°C When Downlink 10 Subframe is the measurement target</p> <p>MS269x series: <1.0% (rms) (When MS269xA-078/178 is not installed. When MS269xA-004/104 is installed, excluding the Batch Measurement.) < 1.3% (rms) (When MS269xA-078/178 is installed, in the CC of the center frequency.)</p> <p>MS2830A : <1.3% (rms) (When MS2830A-078 is not installed. At the input level of -4 dBm when MX2830A-045 is installed) <1.3% (rms) (When MS2830A-078 is installed, in the CC of the center frequency. At the input level of -4 dBm when MX2830A-045 is installed)</p>
Transmitter power accuracy	<p>After CAL execution at 18 to 28°C, input attenuator ≥ 10 dB, The signal measured is within the measurement level range and less than or equal to Input Level.</p> <p>MS269x series: ±0.6 dB (at Pre-Amp Off, or Pre-Amp not installed.) ±1.1 dB (at Pre-Amp On) (When MS269xA-004/104 is installed, excluding the Batch Measurement.)</p> <p>MS2830A: ±0.6 dB (at Pre-Amp Off, or Pre-Amp not installed.) The transmitter power accuracy is obtained by an RSS (root summed square) error of the absolute amplitude accuracy and in-band frequency characteristics.</p>
Waveform display	<p>Provides functions for displaying waveforms below.</p> <p>Constellation EVM vs Subcarrier EVM vs Symbol Power vs Resource Block EVM vs Resource Block Spectral Flatness</p>
Adjacent Channel Power Measurement	
Measurement method	Executes the adjacent channel power measurement function of the Spectrum Analyzer or Signal Analyzer.
Occupied Bandwidth Measurement	
Measurement method	Executes the occupied bandwidth measurement function of the Spectrum Analyzer or Signal Analyzer.
Channel Power Measurement	
Measurement method	Executes the channel power measurement function of the Spectrum Analyzer or Signal Analyzer.
Spectrum Emission Mask Measurement	
Measurement method	Executes the spectrum emission mask measurement function of the Spectrum Analyzer.

Table 1.3-1 Specifications (Cont'd)

Item	Specification
Digitize function	
Function overview	Outputs acquired waveform data to the internal hard disk or to external storage media.
Waveform data	Format : I, Q (32 bit floating point binary format) Level : If 0 dBm is input, the following is assumed: $\sqrt{I^2 + Q^2} = 1$ Level accuracy : Same as absolute amplitude accuracy and in-band frequency characteristics of signal analyzer.
Replay Function	
Function overview	Analyzes each trace from the saved waveform data. Format : I, Q (32 bit floating point binary format) Sampling rate : 50 MHz
Power vs Time	
Function overview	Provides measurements for Transmitter OFF Power, Time Mask, and Transmitter Transient Period.
Dynamic range	121.4 dB (nominal) *1, *2, *3 *1: This is the value when Channel bandwidth is 5 MHz. For the other channel bandwidth, the following formula can be used. $10\log_{10}(\text{Channel bandwidth} / 5.0 \text{ MHz}) \text{ dB}$ *2: Wide Dynamic Range = On, Noise Correction = On *3: Applied to only MS269x series
MIMO Summary	
Function overview	Inputs multiple MIMO signals and measures timing differences.

Chapter 2 Preparation

This chapter describes the preparations required for using the application you are using. Refer to the *MS2690A/MS2691A/MS2692A Signal Analyzer Operation Manual (Mainframe Operation)* or *MS2830A Signal Analyzer Operation Manual (Mainframe Operation)* for common features not included in this manual.

2.1	Part Names	2-2
	2.1.1 Front panel	2-2
	2.1.2 Rear panel	2-8
2.2	Signal Path Setup	2-11
2.3	Application Startup and Selection.....	2-12
	2.3.1 Launching application.....	2-12
	2.3.2 Selecting application.....	2-12
2.4	Initialization and Calibration.....	2-13
	2.4.1 Initialization.....	2-13
	2.4.2 Calibration	2-13

2.1 Part Names

This section describes the panel keys for operating the instrument and connectors used to connect external devices. For general points of caution, refer to the *MS2690A/MS2691A/MS2692A Signal Analyzer Operation Manual (Mainframe Operation)* or *MS2830A Signal Analyzer Operation Manual (Mainframe Operation)*.

2.1.1 Front panel

This section describes the front-panel keys and connectors.

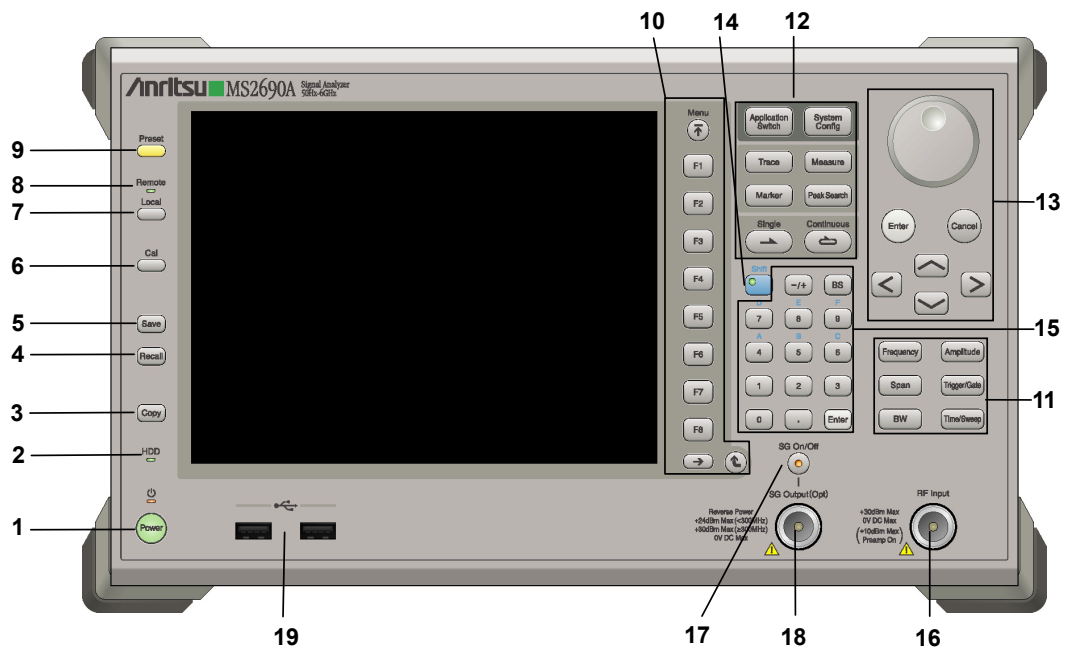

Figure 2.1.1-1 MS269x series front panel

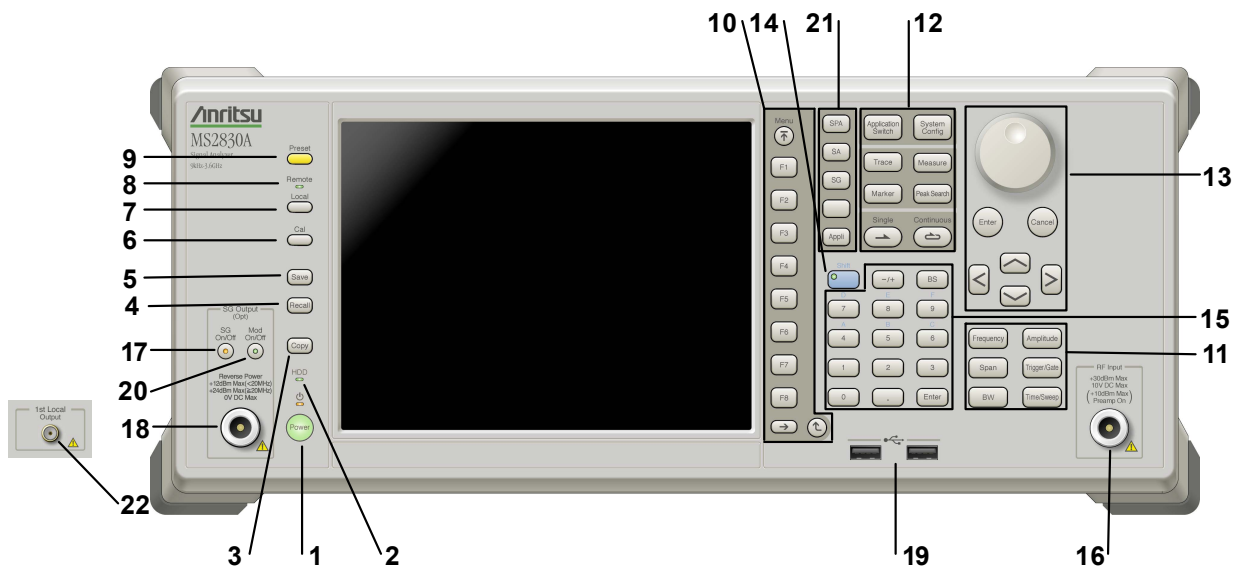
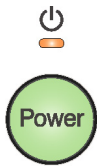







Figure 2.1.1-2 MS2830A front panel

- 1  **Power Switch**
Press to switch between the standby state (AC power supplied) and power-on state. The Power lamp  lights orange at Standby and green at Power On. Press the power switch for about 2 seconds.
- 2  **Hard disk access lamp**
Lights when accessing the internal hard disk.
- 3  **Copy key**
Press to capture display screen and save to file.
- 4  **Recall key**
Press to recall parameter file.
- 5  **Save key**
Press to save parameter file.
- 6  **Cal key**
Press to display the Calibration menu.



Local key

Press to return to local operation from remote control via GPIB, Ethernet, or USB (B), and enable panel settings.



Remote lamp

Lights when in remote-control state.



Preset key

Resets parameters to initial settings.



10



Function keys

Selects or configures function menu displayed on the right of the screen. The function menu is provided in multiple pages and layers.

Press  to fetch next function menu page. The current page number is displayed at the bottom of the function menu, as in “1 of 2”.

Sub-menus may be displayed when a function menu is pressed. Press  to go back to the previous menu. Press  to go back to the top menu.

11





Main function keys 1

Press to set or execute main functions.

Executable functions vary with the current application. When nothing happens with the press, it indicates that the application in use does not support the key.

 Press to set frequency parameters.

 Press to set level parameters.

 No function is assigned to this key.

 Press to set trigger parameters.

 No function is assigned to this key.

 Press to set measurement item parameters.

12



Main function keys 2

Press to set or execute main functions.

Executable functions vary with the current application. When nothing happens with the press, it indicates that the application in use does not support the key.

 Press to switch application.

 Press to display Configuration screen.

 Press to set the trace items or to switch the operation window.

 Press to set measurement item parameters.

 Use when switching graph marker operation.

 Press to set parameters related to the peak search function.

 Press to start single measurement.

 Press to start continuous measurements.

13

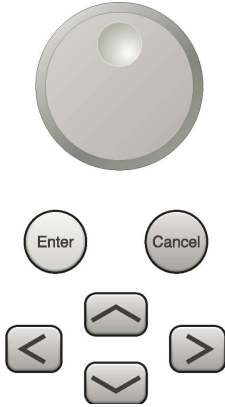

Rotary knob/Cursor key/Enter key/Cancel key

The rotary knob and cursor keys select display items or change settings.

Press  to set the entered or selected data.

Press  to cancel input or selected data.

14



Shift key

Operates keys with functions in blue characters on panel. Press the Shift key so the key lamp is green and then press the target key.

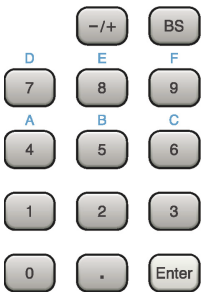

15



Numeric keypad

Enters numbers on parameter setup screens.

Press  to delete the last entered digit or character.

[A] to [F] can be entered by pressing keys  to  while the Shift key lamp  is green.

16

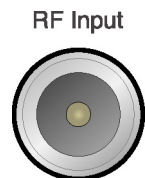

RF Input

RF Input connector

Inputs RF signal. This is an N type input connector.

17



SG On/Off

RF Output Control key

Press  to switch on/off the modulation of RF signal when the Vector Signal Generator option is installed. The RF output control key lamp lights orange when the RF signal output is set to On.

This is not available when the Option 044/045 is installed. (Only for MS2830A)

18 SG Output(Opt)



RF Output connector (when Option 020 installed)

Outputs RF signal, when the Vector Signal Generator option is installed. This is an N type output connector.

This is not available when the Option 044/045 is installed. (Only for MS2830A)

19

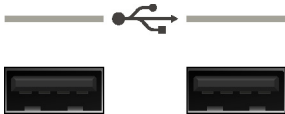

USB connector (type A)

Connect the accessory USB keyboard, mouse or USB memory.

20



Modulation control key (MS2830A only)

Press to switch on/off the modulation of RF signal when the Vector Signal Generator option is installed. The lamp  on the key lights up in green in the modulation On state.

This is not available when the Option 044/045 is installed.

21



Application key (MS2830A only)

Press to switch between applications.



Press to display the Spectrum Analyzer main screen.



Press to display the Signal Analyzer main screen, when Option 005/105 and 006/106 are installed.



Press to display the Signal Generator main screen, when Vector Signal Generator option is installed.



This is a blank key. Not used.



Displays the main screen of the application that is selected using the Application Switch (Auto), or displays that of the pre-selected application (Manual).

For details, refer to 3.5.4 “Changing application layout” in *MS2830A Signal Analyzer Operation Manual (Mainframe Operation)*.

22



1st Local Output connector (Only for MS2830A)

This is available when the Option 044/045 is installed.

Supplies local signal and bias current to the external mixer, and receives the IF signal with its frequency converted.

2.1.2 Rear panel

This section describes the rear-panel connectors.

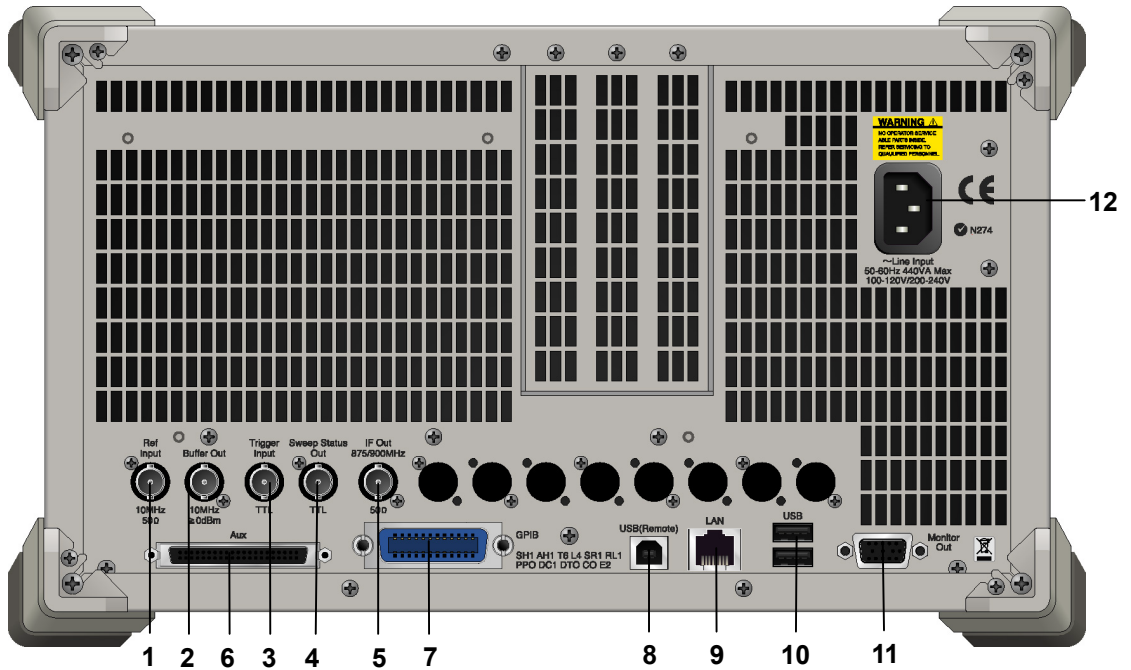

Figure 2.1.2-1 MS269x series rear panel

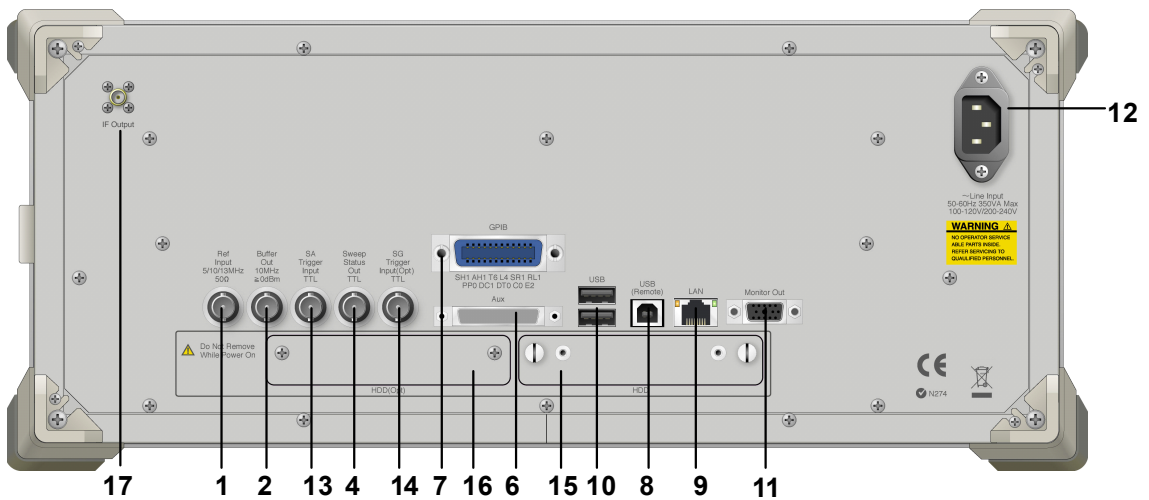





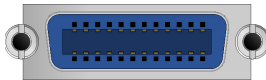











Figure 2.1.2-2 MS2830A rear panel

- 1** **Ref Input**

 Ref Input connector (reference frequency signal input connector)
 Inputs external reference frequency signal. It is for inputting reference frequency signals with higher accuracy than the instrument's internal reference signal, or for synchronizing the frequency of the MS2690A/MS2691A/MS2692A or MS2830A to that of other equipment. The following frequencies are supported:
 MS269x series: 10 MHz/13 MHz
 MS2830A: 5 MHz/10 MHz/13 MHz
- 2** **Buffer Out**

 Buffer Out connector (reference frequency signal output connector)
 Outputs the internal reference frequency signal (10 MHz). It is for synchronizing frequencies between other equipment and the MS2690A/MS2691A/MS2692A or MS2830A.
- 3** **Trigger Input**

 Trigger Input connector (MS269x series only)
 Inputs trigger signal from external device.
- 4** **Sweep Status Out**

 Sweep Status Out connector
 Outputs signal when internal measurement is performed or measurement data is obtained.
- 5** **IF Out 875/900MHz**

 IF Out connector (MS269x series only)
 Not used.
- 6** **Aux**

 AUX connector
 Not used.
- 7** **GP-IB**

 GPIB connector
 For external control via GPIB.
- 8** **USB(Remote)**

 USB connector (type B)
 For external control via USB.

Chapter 2 Preparation

- 9** **LAN**
 Ethernet connector
Connects PC or Ethernet network.
- 10** **USB**

 USB connector (type A)
Used to connect a USB keyboard or mouse or the USB memory supplied.
- 11** **Monitor Out**
 Monitor Out connector
Connects external display.
- 12**

~Line Input
50-60Hz 440VA Max
100-120V/200-240V
AC inlet
Supplies power.
- 13** **SA
Trigger
Input
TTL**
 SA Trigger Input connector (MS2830A only)
This is a BNC connector for inputting external trigger signal (TTL) for SPA and SA applications.
- 14** **SG
Trigger
Input(Opt)
TTL**
 SG Trigger Input connector (MS2830A only)
This is a BNC connector for inputting external trigger signal (TTL) for Vector Signal Generator option.
- 15** **HDD**
HDD slot (MS2830A only)
This is a standard hard disk slot.
- 16** **HDD(Opt)**
HDD slot for Option (MS2830A only)
This is a hard disk slot for the options.
- 17**  IF output connector (Only for MS2830A)
Monitor output of the internal IF signal.
This is available when the Option 044/045 is installed.

2.2 Signal Path Setup

As shown in Figure 2.2-1, connect the instrument and the DUT using an RF cable, so that the signal to be tested is input to the RF Input connector. To prevent an excessive level signal from being input, do not input the signal before setting the input level using this application.

2

Preparation

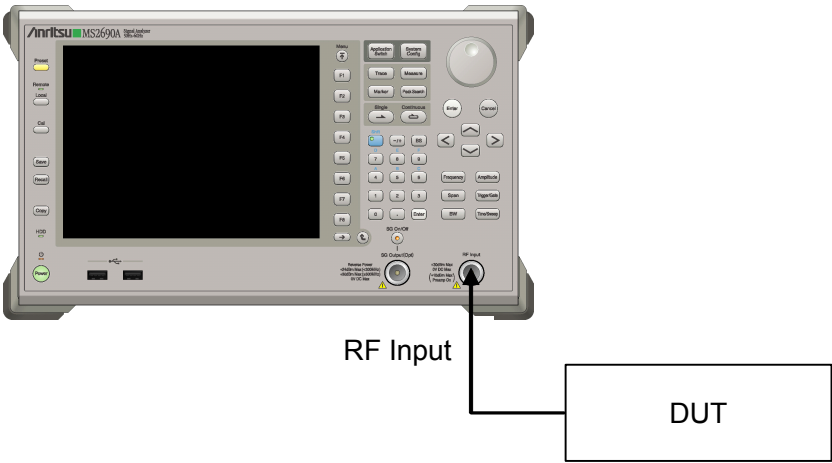

Figure 2.2-1 Signal path setup example

Set the reference signal and/or trigger signal paths from external sources, as required.

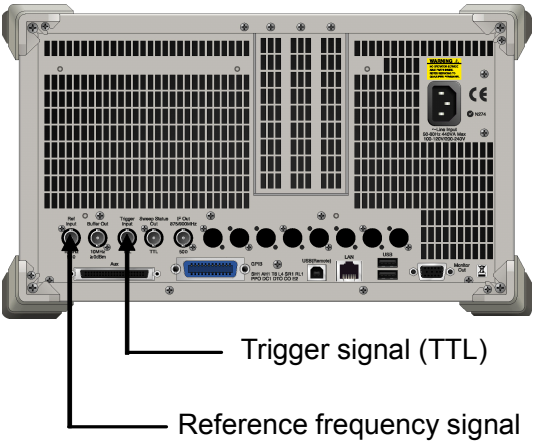

Figure 2.2-2 External signal input

2.3 Application Startup and Selection

To use this application, it is necessary to load (start up) and select the application.





2.3.1 Launching application

The application startup procedure is described below.

Note:

The XXX indicates the application name currently in use.

<Procedure>

1. Press  to display the Configuration screen.
2. Press  (Application Switch Settings) to display the Application Switch Registration screen.
3. Press  (Load Application Select), and move the cursor to “XXX” in the **Unloaded Applications** list.
If “XXX” is displayed in the **Loaded Applications** list, this means that the application is already loaded.
If “XXX” appears in neither the **Loaded Applications** nor **Unloaded Applications** list, this means that the application has not been installed.
4. Press  (Set) to load the application. If “XXX” is displayed in the **Loaded Applications** list, this means that the application is already loaded.

2.3.2 Selecting application

The selection procedure is described below.

<Procedure>

1. Press  to display the Application Switch menu.
2. Press the menu function key displaying “XXX”.

The application can also be selected with mouse, by clicking “XXX” on the task bar.

2.4 Initialization and Calibration

This section describes the parameter settings and the preparations required before starting measurement.

2.4.1 Initialization



After selecting this application, first perform initialization. Initialization returns the settable parameters to their default value in order to clear the measurement status and measurement results.

Note:

When another software application is switched to or this application is unloaded (ended), the application keeps the parameter settings at that time. The parameter values that were last set will be applied when this application is selected next time.

The initialization procedure is as follows.

<Procedure>

1. Press  to display the Preset function menu.
2. Press  (Preset).

2.4.2 Calibration

Perform calibration before performing measurement. Calibration sets the level accuracy frequency characteristics for the input level to flat, and adjusts level accuracy deviation caused by internal temperature fluctuations. Calibration should be performed when first performing measurement after turning on power, or if beginning measurement when there is a difference in ambient temperature from the last time calibration was performed.

<Procedure>

1. Press  to display the Application Cal function menu.
2. Press  (SIGANA All).

For details on calibration functionality only executable with this instrument, refer to the *MS2690A/MS2691A/MS2692A Signal Analyzer Operation Manual (Mainframe Operation)* or *MS2830A Signal Analyzer Operation Manual (Mainframe Operation)*.

Chapter 3 Measurement

This chapter describes the measurement functions and parameters of the MX269022A, together with descriptions of how to set them.

3.1	Basic Operation	3-6
3.1.1	Screen layout.....	3-6
3.1.2	Types of Measurement Function.....	3-9
3.1.3	Performing Measurement.....	3-10
3.1.4	Measurement Signals and Troubleshooting Errors	3-11
3.2	Setting Frequency and Level	3-12
3.2.1	Carrier Frequency.....	3-12
3.2.2	Input Level	3-12
3.2.3	Offset	3-13
3.2.4	Pre-Amp	3-14
3.2.5	Auto Range.....	3-14
3.3	Setting Trigger	3-15
3.3.1	Trigger Switch.....	3-15
3.3.2	Trigger Source.....	3-15
3.3.3	Trigger Slope	3-16
3.3.4	Trigger Delay	3-16
3.4	Common Settings	3-17
3.4.1	Channel Bandwidth	3-17
3.4.2	Test Model.....	3-17
3.4.3	Test Model Version.....	3-17
3.4.4	Uplink-downlink Configuration.....	3-18
3.4.5	Special Subframe Configuration.....	3-19
3.4.6	Synchronization Mode	3-20
3.4.7	Cell ID.....	3-20
3.4.8	Reference Signal Boosting.....	3-21
3.4.9	Number of Antenna Ports.....	3-21
3.4.10	Antenna Port.....	3-22
3.5	Setting Modulation Analysis.....	3-23
3.5.1	Starting Subframe Number.....	3-23
3.5.2	Measurement Interval.....	3-25
3.5.3	PDSCH Modulation Scheme	3-26
3.5.4	Total EVM & Constellation Composite	3-27
3.5.5	EVM Window Length.....	3-28
3.5.6	PBCH - On / Off.....	3-29
3.5.7	PBCH - Power Auto/Manual.....	3-30
3.5.8	PBCH - Power Boosting	3-30
3.5.9	Precautions at Power Auto Setting.....	3-31
3.5.10	P-SS - On/Off	3-31
3.5.11	P-SS - Power Auto / Manual	3-32

- 3.5.12 P-SS - Power Boosting..... 3-32
- 3.5.13 S-SS - On/Off 3-32
- 3.5.14 S-SS - Power Auto/Manual 3-33
- 3.5.15 S-SS - Power Boosting..... 3-33
- 3.5.16 PDCCH - On / Off..... 3-33
- 3.5.17 PDCCH - Power Auto / Manual 3-34
- 3.5.18 PDCCH - Power Boosting 3-34
- 3.5.19 PCFICH - On/Off 3-34
- 3.5.20 PCFICH - Power Auto / Manual 3-35
- 3.5.21 PCFICH - Power Boosting..... 3-35
- 3.5.22 PHICH - On / Off..... 3-36
- 3.5.23 PHICH - Power Auto / Manual..... 3-37
- 3.5.24 PHICH - Power Boosting 3-37
- 3.5.25 PDSCH - Power Auto / Manual 3-38
- 3.5.26 PDSCH - Power Boosting 3-38
- 3.5.27 PHICH - TDD $m_i=1$ (E-TM) On/Off..... 3-39
- 3.5.28 PHICH - Ng..... 3-39
- 3.5.29 PHICH - Duration..... 3-39
- 3.5.30 Number of PDCCH Symbols - Auto/Manual .. 3-40
- 3.5.31 Number of PDCCH Symbols 3-41
- 3.5.32 PDCCH Mapping 3-41
- 3.5.33 PDCCH Format 3-42
- 3.5.34 Number of PDCCHs 3-43
- 3.5.35 Channel Estimation 3-43
- 3.5.36 DwPTS 3-43
- 3.5.37 PDSCH EVM Calculation 3-44
- 3.5.38 Test Model Starting Frame Type..... 3-44
- 3.5.39 Measurement Filter Type 3-45
- 3.5.40 Extended Freq Lock Range..... 3-45
- 3.5.41 Operating Detail Settings Dialog 3-45
- 3.5.42 Analysis Frame Position..... 3-46
- 3.5.43 Analysis Offset Time..... 3-46
- 3.6 Modulation Analysis Measurement and Results..... 3-47
 - 3.6.1 Setting Storage Mode/Count 3-48
 - 3.6.2 Trace Mode 3-49
 - 3.6.3 Frame Offset..... 3-50
 - 3.6.4 Main Numeric Results 3-51
 - 3.6.5 Setting EVM Display Units and Scale 3-51
 - 3.6.6 Constellation..... 3-52
 - 3.6.7 EVM vs Subcarrier..... 3-53
 - 3.6.8 EVM vs Symbol 3-55
 - 3.6.9 Spectral Flatness..... 3-57
 - 3.6.10 PDSCH Constellation 3-59
 - 3.6.11 Subframe Number 3-59

3.6.12	Resource Block Number	3-60
3.6.13	Power vs RB.....	3-61
3.6.14	EVM vs RB	3-62
3.6.15	Marker	3-63
3.6.16	Summary	3-66
3.6.17	Test Model Summary	3-69
3.7	Power vs Time Setting.....	3-71
3.7.1	Wide Dynamic Range.....	3-72
3.7.2	Noise Correction.....	3-73
3.7.3	Pre-Amp Mode	3-73
3.7.4	Channel bandwidth.....	3-74
3.7.5	Setting smoothing (Smoothing).....	3-74
3.7.6	Select Mask.....	3-75
3.7.7	Mask Setup.....	3-75
3.7.8	Frame Sync	3-80
3.7.9	Limiter Mode.....	3-81
3.8	Measurement and Result for Power vs Time	3-84
3.8.1	Averaging (Storage)	3-86
3.8.2	Main Numeric Results	3-87
3.8.3	Marker	3-89
3.9	MIMO Summary Settings.....	3-91
3.9.1	Number of Antenna Ports.....	3-91
3.9.2	Antenna Port.....	3-91
3.9.3	Active Antenna Threshold	3-92
3.10	MIMO Summary Measurement Results	3-93
3.10.1	Numeric Results	3-94
3.11	Setting Batch Measurement	3-95
3.11.1	Common Settings : Storage Mode	3-95
3.11.2	Common Settings : Storage Count.....	3-95
3.11.3	Common Settings : Storage Mode for Unwanted Emissions	3-95
3.11.4	Common Settings : Storage Count for Unwanted Emissions	3-96
3.11.5	Common Settings : Starting Subframe Number.....	3-96
3.11.6	Common Settings : Measurement Interval.....	3-97
3.11.7	Common Settings : Starting OFDM Symbol Number.....	3-97
3.11.8	Common Settings : Measurement Interval for Unwanted Emissions.....	3-98
3.11.9	Common Settings : Modulation Analysis.....	3-98
3.11.10	Common Settings : OBW.....	3-99
3.11.11	Common Settings : ACLR.....	3-99

3.11.12	Common Settings : OBUE (Operating Band Unwanted Emissions).....	3-99
3.11.13	Band Settings : Measurement Item	3-100
3.11.14	Band Settings : Carrier Frequency	3-101
3.11.15	Band Settings : Input Level.....	3-101
3.11.16	Band Settings : Pre-Amp	3-102
3.11.17	Band Settings : Level Offset	3-102
3.11.18	Band Settings : Offset Value.....	3-102
3.11.19	Band Settings : Contiguous Mode	3-103
3.11.20	Band Settings : OBUE Standard.....	3-103
3.11.21	Band Settings : OBUE Standard Additional	3-104
3.11.22	CC Settings : Measurement Item.....	3-104
3.11.23	CC Settings : Frequency Band	3-105
3.11.24	CC Settings : Frequency Offset	3-105
3.11.25	CC Settings : Channel Bandwidth	3-106
3.11.26	CC Settings : Test Model.....	3-106
3.11.27	CC Settings : Test Model Starting Frame Type	3-107
3.11.28	CC Settings : Uplink-downlink Configuration.....	3-107
3.11.29	CC Settings : Special Subframe Configuration.....	3-108
3.11.30	CC Settings : Synchronization Mode	3-108
3.11.31	CC Settings : Cell ID	3-109
3.11.32	CC Settings : CRS Power Boosting.....	3-109
3.11.33	CC Settings : CRS Number of Antenna Ports.....	3-110
3.11.34	CC Settings : CSI-RS Number of Antenna Ports.....	3-110
3.11.35	CC Settings : CRS Antenna Port	3-111
3.11.36	CC Settings : CSI-RS Antenna Port	3-111
3.11.37	CC Settings : PDSCH Modulation Scheme	3-112
3.11.38	CC Settings : EVM Window Length	3-112
3.11.39	CC Settings : Channel Estimation	3-113
3.11.40	CC Settings : DwPTS.....	3-113
3.11.41	CC Settings : DwPTS for Unwanted Emissions.....	3-113
3.11.42	CC Settings : Measurement Filter Type.....	3-114
3.11.43	CC Settings : PBCH On/Off	3-114
3.11.44	CC Settings : PBCH Power Auto/Manual ..	3-115
3.11.45	CC Settings : PBCH Power Boosting	3-115
3.11.46	CC Settings : P-SS On/Off.....	3-116
3.11.47	CC Settings : P-SS Power Auto/Manual....	3-116
3.11.48	CC Settings : P-SS Power Boosting	3-117

3.11.49	CC Settings : S-SS On/Off.....	3-117
3.11.50	CC Settings : S-SS Power Auto/Manual....	3-118
3.11.51	CC Settings : S-SS Power Boosting	3-118
3.11.52	CC Settings : PDCCH On/Off	3-119
3.11.53	CC Settings : PDCCH Power Auto/Manual.....	3-119
3.11.54	CC Settings : PDCCH Power Boosting.....	3-120
3.11.55	CC Settings : PCFICH On/Off.....	3-120
3.11.56	CC Settings : PCFICH Power Auto/Manual.....	3-121
3.11.57	CC Settings : PCFICH Power Boosting	3-121
3.11.58	CC Settings : PHICH On/Off.....	3-122
3.11.59	CC Settings : PHICH Power Auto/Manual .	3-122
3.11.60	CC Settings : PHICH Power Boosting	3-123
3.11.61	CC Settings : PDSCH Power Auto/Manual	3-123
3.11.62	CC Settings : PDSCH Power Boosting.....	3-124
3.11.63	CC Settings : PHICH - Ng.....	3-124
3.11.64	CC Settings : PHICH Duration	3-125
3.11.65	CC Settings : Number of PDCCH Symbols - Auto/Manual.....	3-125
3.11.66	CC Settings : Number of PDCCH Symbols for Subframe 1 and 6	3-126
3.11.67	CC Settings : Number of PDCCH Symbols	3-126
3.11.68	CC Settings : PDCCH Mapping	3-127
3.11.69	CC Settings : PDCCH Format	3-127
3.11.70	CC Settings : Number of PDCCHs	3-128
3.11.71	CC Settings : CSI-RS On/Off.....	3-128
3.11.72	CC Settings : CSI-RS Configuration	3-129
3.11.73	CC Settings : CSI-RS Periodicity T.....	3-129
3.11.74	CC Settings : CSI-RS Subframe Offset	3-130
3.12	Batch Measurement Results.....	3-131
3.12.1	Measurement results	3-131
3.13	Spectrum Measurement	3-134
3.13.1	Adjacent Channel Leakage Power Measurement (ACP).....	3-134
3.13.2	Channel Power Measurement (Channel Power).....	3-135
3.13.3	Occupied Bandwidth Measurement (OBW) .	3-135
3.13.4	Spectrum Emission Mask Measurement (SEM)	3-136
3.13.5	Advanced Settings.....	3-136

3.1 Basic Operation

3.1.1 Screen layout

This section describes the screen layout of the MX269022A.

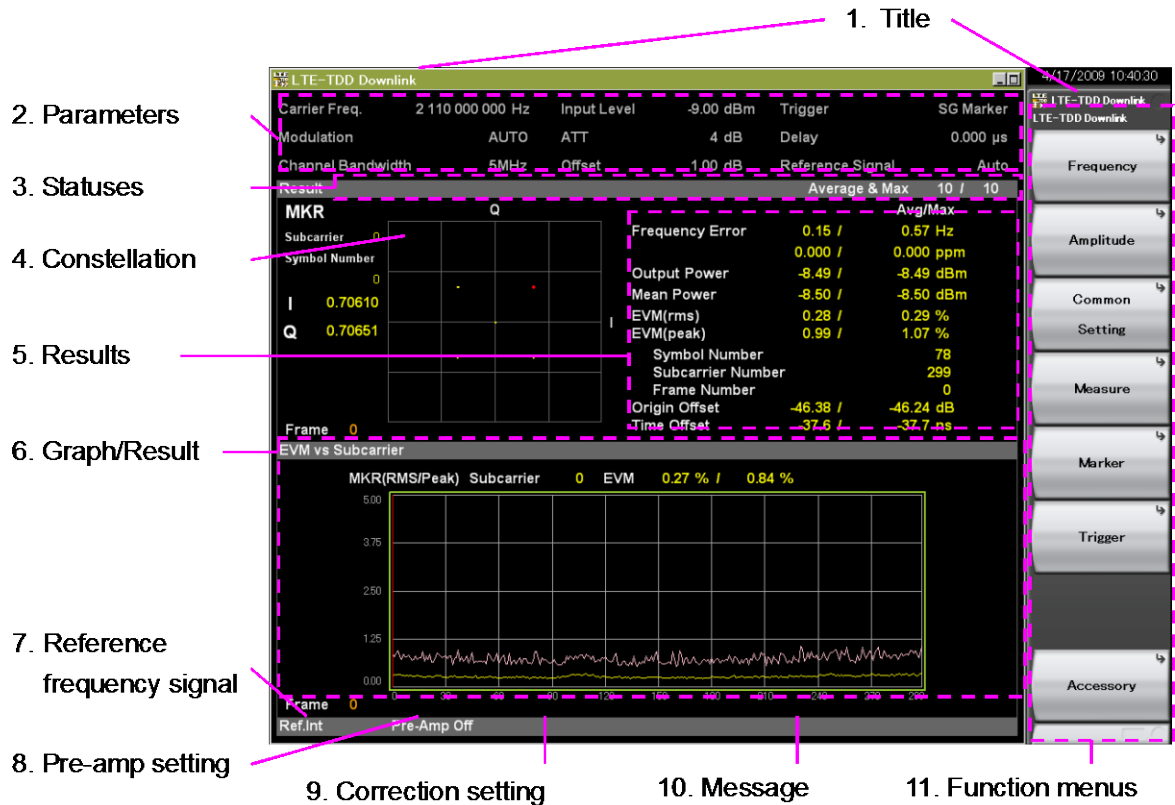



Figure 3.1.1-1 Screen Appearance (Modulation Analysis)

1. Title
This displays the title of the application. The title can be changed.  6.2 Setting Title
2. Measurement Parameter
This displays the settings of the main parameters.

Carrier Freq.	Input signal carrier frequency setting
Modulation	PDSCH modulation method setting (Displayed when Test Model set to Off)
Test Model	Test model setting (Displayed when Test Model not set to Off)
Channel Bandwidth	Channel bandwidth setting
Input Level	Average power setting while input signal transmission on
ATT	Internal attenuator setting (automatic)

Offset	Level offset setting (displayed at Offset On)
Trigger	Trigger signal type setting (displayed at Trigger Switch On)
Delay	Trigger delay setting (displayed at Trigger Switch On)
Reference Signal	Reference Signal detection method

3. Measurement Status

This displays the measurement results of status and storage status.

⬆️ Level Over indicates that the level of the signal input for performing measurement is too large for the settings. When Level Over is displayed, either increase the Input Level value or decrease the level of the input signal and measure again.

 3.2.2 Input Level

"Measuring" indicates that measurement is in progress.

 3.1.3 Performing Measurement

Signal Abnormal indicates that frame synchronization with the input signal has failed. Measurement results are not displayed on the screen when this happens. When the signal abnormal is displayed, check the status of the input signal and the correct settings for this application.

 3.1.4 Measurement Signals and Troubleshooting Errors

The storage status is indicated at the right side of the measurement status field. It is not displayed when Storage Mode is set to Off. The numeric value at the right side of "/" indicates the Storage Count setting and the numeric value at the left side indicates the completed measurement count.

4. Constellation

This field displays the symbol constellation for the specified range. The marker positions and I and Q Coordinates for the marker positions are displayed on the left side of the constellation screen.

The constellation is displayed when Modulation Analysis is selected.

5. Numeric Results/Graph (Upper)

This displays the measurement results for the currently selected Measure function and Trace Mode.

6. Graph/Numeric Results (Lower)

This displays the measurement results for the currently selected Measure Function and Trace Mode. The Trace Mode contents are displayed when Modulation Analysis is selected.

7. Reference Frequency Signal

This indicates that type and status of the detected reference frequency signal.

Ref.Int	Internal reference frequency signal/lock status
Ref.Ext	External reference frequency signal/lock status
Ref.Int Unlock	Internal reference frequency signal/unlock status
Ref.Ext Unlock	External reference frequency signal/unlock status

8. Pre-amplifier Setting

This indicates a pre-amplifier settings status.

Pre-Amp On	Preamplifier On
Pre-Amp Off	Preamplifier Off or not installed

 3.2.4 Pre-Amp

9. Correction Setting

This is displayed when the Correction function is On.

Refer to the *MS2690A/MS2691A/MS2692A Signal Analyzer Operation Manual* or *MS2830A Signal Analyzer Operation Manual*.

10. Message

The indicates the cause of the Signal Abnormal display.

"Synchronizing signal cannot be detected" indicates that synchronization with the input signal was lost.

 3.1.4 Measurement Signals and Troubleshooting Errors

11. Function Menu

This indicates the functions that can be executed by the relevant function keys.

3.1.2 Types of Measurement Function

This application has the following measurement functions.



- (1) Modulation Analysis
Measures the modulation accuracy such as frequency error, EVM, etc.
- (2) Power vs Time
Measures the time fluctuations of power of the obtained measured signal.
- (3) ACP (FFT)
Recalls the ACP function of the Signal Analyzer function. This function is only enabled when Channel Bandwidth is set to 1.4, 3, and 5 MHz.
- (4) ACP (Swept)
Recalls the ACP function of the Spectrum Analyzer function.
- (5) Channel Power (FFT)
Calls Signal Analyzer function and Channel Power function
- (6) Channel Power (Swept)
Recalls the Channel Power function of the Spectrum Analyzer function.
- (7) OBW (FFT)
Recalls the OBW function of the Signal Analyzer function.
- (8) OBW (Swept)
Recalls the OBW function of the Spectrum Analyzer function.
- (9) Spectrum Emission Mask (Swept)
Recalls the spectrum emission mask function of the Spectrum Analyzer function.

3.1.3 Performing Measurement

There are two measurement modes: single and continuous. Measurement is performed once in the single measurement mode, and continuously in the continuous measurement mode.



Single Measurement

After capturing an input signal based upon the settings of Capture Time, the selected measurement items are measured only for the measurement count (Storage Count) before measurement is stopped.

1. Press  to select the measurement function.
2. Press .

Continuous Measurement

After capturing an input signal based upon the settings of Capture Time, the selected measurement items are continuously measured for the measurement count (Storage Count).

1. Press  to select the measurement function.
2. Press .

 4.1.1 Loading IQ Data

Notes:

- The two measurement modes are not available when the Replay function is executed. For the Replay function, analysis starts when the IQ data file is specified.

 4.2 Replay Function

- The continuous measurement cannot be performed at the Power vs Time Measurement. The measurement mode is switched forcefully from the continuous measurement to the single measurement.

3.1.4 Measurement Signals and Troubleshooting Errors

Table 3.1.4-1 lists the minimum requirements for measuring with the MX269022A. To measure with this application, check that the input signal satisfies the conditions listed in Table 3.1.4-1 and that the application settings match these conditions.

Table 3.1.4-1 Measurement Signals (minimum conditions)

Item	Value
Wireless standard	3GPP TS36.211 V8.6.0 (2009-03)
Multiplex method	TDD
Frame length (1 frame)	10 ms = 10 subframes
Channel Bandwidth	1.4 / 3 / 5 / 10 / 15 / 20 MHz
Cyclic prefix (CP)	Normal cyclic prefix
Uplink-downlink configuration	0 to 6 (DL Subframe included in subframe)
Special subframe configuration	0 to 8 (DwPTS included)
Physical channels	PDSCH (required), PBCH, PCFICH, PDCCH, PHICH
Physical signals	Reference signal (required), Synchronization signal
Test Model	E-TM1.1 / 1.2 / 2 / 2a / 3.1 / 3.1a / 3.2 / 3.3

Note:

This application is for frame synchronizing the Reference or Synchronization signals (determined by Synchronization Mode settings) included in 10 Downlink subframes (5 frames max.).

If Signal Abnormal is displayed, consider the following possible causes. Check the input signal parameter settings and try to measure again.

- (1) The Carrier Frequency Settings do not match the input signal carrier frequency.
- (2) The input level is too low for the Input Level setting.
- (3) The Synchronization Mode is set to Synchronization Signal but there is no Synchronization Signal in the input signal.
- (4) The Synchronization Mode is set to Reference Signal but the set Cell ID is different from the input signal.

3.2 Setting Frequency and Level

3.2.1 Carrier Frequency

This sets the carrier frequency of the input signal.

You cannot set Carrier Frequency when the Replay function is executed.



Procedure

 >  (Frequency) >  (Carrier Frequency)

or



Range 100 MHz to the upper limit of the main unit
Minimum resolution 1 Hz
Default 2110 MHz



3.2.2 Input Level

This sets the average power (rms) in the input signal transmission-on period. The difference between the average power and the peak power (crest factor) with this application is 14 dB. When calling the signal analyzer or spectrum analyzer ACP, Channel Power, OBW, and SEM measurement functions from this application, set Input Level +14 dB as Reference Level.

You cannot set Input Level when the Replay function is executed.



Procedure

 >  (Amplitude) >  (Input Level)

or



Range With Pre-Amp On or Pre-Amp Mode On at Power vs Time measurement:
 (-80.00 + Offset Value) to (10.00 + Offset Value) dBm
 With Pre-Amp Off:
 (-60.00 + Offset Value) to (30.00 + Offset Value) dBm
Minimum resolution: 0.01 dB
Default -10.00 dBm

3.2.3 Offset

This adds the displayed offset to the Input Level setting. Input the increase or decrease in the level due to devices such as cables, attenuators, amplifiers, etc., between this equipment and the measurement target as the level offset and set the same input level as the output level at the antenna of the DUT.

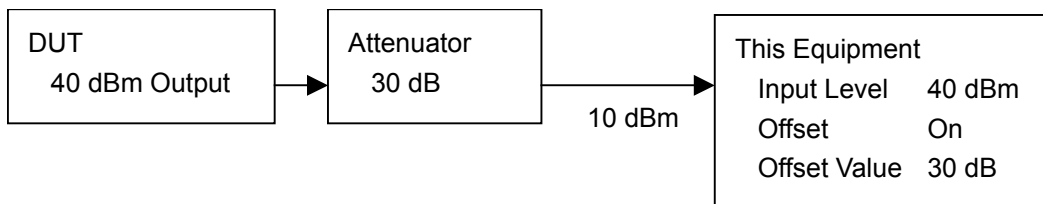

Figure 3.2.3-1 Setting Input Level and Level Offset

Offset

Procedure

Menu \uparrow > F2 (Amplitude) > F7 (Offset)

Options On, Off

Default Off

Note:

Offset is set automatically to on when setting Offset Value.

Offset Value

Procedure

Menu \uparrow > F2 (Amplitude) > F8 (Offset Value)

Range -99.99 to +99.99 dB

Minimum resolution: 0.01 dB

Default 0.00 dB

Note:

The correction set at the System Config. screen is used irrespective of the Offset Value.

3.1.1 Screen layout



3.2.4 Pre-Amp

The MS2690A/MS2691A/MS2692A Option 008/108 6 GHz Preamplifier or MS2830A Option 008/108 Preamplifier (hereinafter referred to as “Option 008”) is installed in this instrument. The level sensitivity can be increased by setting this pre-amp to On.

You cannot set Pre-Amp when the Replay function is executed.

 4.2 Replay Function

Procedure

 ^{Menu} >  (Amplitude) >  (Pre-Amp)

Options On, Off

Default Off

Notes:

- If opt-008 is not installed, the Pre-Amp menu is not displayed.
- When Wide Dynamic Range is On at Power vs Time measurement, the Pre-Amp menu is displayed in gray and the function is disabled.

3.2.5 Auto Range

This function adjusts input level according to input signal.



You cannot set Auto Range when the Replay function is executed.

 4.2 Replay Function

You cannot set Auto Range when Limiter Mode is On.

 3.7.9 Limiter Mode

Procedure

 ^{Menu} >  (Amplitude) >  (Auto Range)

3.3 Setting Trigger

The trigger signal determining the measurement start timing may be either the external input signal from the Trigger Input connector on the back panel or an internal signal generated from the optional Vector Signal Generator. Using this application, a header-timing signal with a 10-ms frame interval is input.

You cannot set Trigger when the Replay function is executed.

 4.2 Replay Function



3

Measurement



3.3.1 Trigger Switch

This enables/disables the trigger function.

Procedure

 >  (Trigger) >  (Trigger Switch)

or

 >  (Trigger Switch)



Options On (Enabled), Off (Disabled)

Default Off



3.3.2 Trigger Source

This sets the trigger signal type.

Procedure

 >  (Trigger) >  (Trigger Source)

or

 >  (Trigger Source)

Options

External Measurement starts with external trigger signal input.



SG Marker Starts measurement by the timing of internal Vector Signal Generator option.

Default External



3.3.3 Trigger Slope

This sets the trigger polarity.

Procedure

 >  (Trigger) >  (Trigger Slope)

or

 >  (Trigger Slope)



Options

Rise	Synchronizes with rising edge of the trigger.
Fall	Synchronizes with falling edge of the trigger.
Default	Rise



3.3.4 Trigger Delay

This sets the difference between the trigger signal detection timing and the measurement start timing.

Procedure

 >  (Trigger) >  (Trigger Delay)

or

 >  (Trigger Delay)

Range	When the Measure is Modulation Analysis or MIMO Summary. -2 s to + 2 s When the Measure is Batch Measurement. -0.5 to + 0.5 s
Minimum resolution:	20 ns
Default	0 s



3.4 Common Settings

This section explains the shade parameters used by all measurement functions of this application. These parameters are mainly referenced for performing synchronization processing related to the input signal.



3.4.1 Channel Bandwidth

This sets the channel width.

Procedure

 >  (Common Setting) >  (Channel Bandwidth)

or

 >  (Modulation Analysis) >  (Channel Bandwidth)

Options 1.4 MHz, 3 MHz, 5 MHz, 10 MHz, 15 MHz, 20 MHz

Default 5 MHz



3.4.2 Test Model

When the input signal is an E-UTRA Test Model (Test Model hereafter) defined by 3GPP TS36.141, Test Model is set. When Test Model is set, the parameters defined by Test Model are fixed. If there is no Test Model, Off is set.

Procedure

 >  (Common Setting) >  (Test Model)

or

 >  (Modulation Analysis) >  (Detail Settings)



Options Off, E-TM1.1, E-TM1.2, E-TM2, E-TM2a, E-TM3.1, E-TM3.1a, E-TM3.2, E-TM3.3

Default Off

3.4.3 Test Model Version

This sets the version of 3GPP TS36.141 when the input signal is an E-UTRA Test Model (Test Model hereafter) defined by 3GPP TS36.141.

Procedure

 >  (Modulation Analysis) >  (Detail Settings)

Options 3GPP TS36.141 V8.2.0 (2009-03),
3GPP TS36.141 V8.3.0 (2009-05)

Default 3GPP TS36.141 V8.3.0 (2009-05)

3.4.4 Uplink-downlink Configuration

This sets the position of the Downlink subframe in the frame.

Table 3.4.4-1 shows the relation between the Uplink-downlink Configuration and subframe type.

Table 3.4.4-1 Relation between Uplink-downlink Configuration and Subframe Type

Uplink-downlink Configuration	Subframe number									
	0	1	2	3	4	5	6	7	8	9
0	D	S	U	U	U	D	S	U	U	U
1	D	S	U	U	D	D	S	U	U	D
2	D	S	U	D	D	D	S	U	D	D
3	D	S	U	U	U	D	D	D	D	D
4	D	S	U	U	D	D	D	D	D	D
5	D	S	U	D	D	D	D	D	D	D
6	D	S	U	U	U	D	S	U	U	D

D: Downlink subframe

U: Uplink subframe

S: Special subframe (DwPTS + GP + UpPTS)

This can be set when Test Model is Off. The setting is fixed to 3 when Test Model is not Off.

Procedure

- Menu  >  (Common Setting)
- >  (Uplink-downlink Configuration)

Range 0 to 6

Default 3

3.4.5 Special Subframe Configuration

This sets the configuration of the special subframe.



The special subframe is composed of three parts: the DwPTS (Downlink part of the special subframe), the GP (Guard Period), and the UpPTS (Uplink part of the special subframe). The length of the DwPTS and UpPTS are determined by the Special Subframe Configuration as shown in Table 3.4.5-1.

Table 3.4.5-1 Special Subframe Configuration

Special Subframe Configuration	DwPTS	UpPTS
0	$6592 \times T_s$	2192 $\times T_s$
1	$19760 \times T_s$	
2	$21952 \times T_s$	
3	$24144 \times T_s$	
4	$26366 \times T_s$	
5	$6592 \times T_s$	4384 $\times T_s$
6	$19760 \times T_s$	
7	$21952 \times T_s$	
8	$24144 \times T_s$	

This can be set when Test Model is Off. It is fixed to 8 when Test Model is not Off.

Procedure

 >  (Common Setting)
 >  (Special Subframe Configuration)

Range 0 to 8

Default 8

3.4.6 Synchronization Mode

This sets the type of physical signal used for synchronization processing with the input signal. When Reference Signal is selected, Cell ID must also be set correctly.

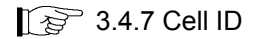

This can be set when Test Model is Off. It is fixed to Synchronization Signal when Test Model is not Off.

Procedure

> (Common Setting) > (Synchronization Mode)

or

> (Modulation Analysis) > (Detail Settings)

Options Reference Signal, Synchronization Signal

Default Synchronization Signal

3.4.7 Cell ID

This sets the Cell ID.

It is used to create the Reference Signal for synchronization and for defining the physical channel depending on the Cell ID value. This parameter is only enabled when Synchronization Mode is set to Reference Signal.

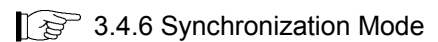

Procedure

> (Common Setting) > (Reference Signal)
> (Cell ID)

or

> (Modulation Analysis) > (Detail Settings)

Range 0 to 503

Default 0





3.4.8 Reference Signal Boosting

This sets the Reference Signal Boosting level. This application uses the power value for the specified Reference Signal plus the value specified by this parameter as the reference level for each physical channel and the physical signal (0 dB).



$$\text{Physical Channel / Physical Signal Reference Level} \\ = \text{Reference Signal Power} - \text{Reference Signal Boosting Level}$$

It can be set when Test Model is Off. It is fixed to 0.000 dB when Test Model is not Off.

Procedure

 >  (Common Setting) >  (Reference Signal)
>  (Power Boosting)

or

 >  (Modulation Analysis) >  (Detail Settings)





Range -20.000 dB to +20.000 dB
Default 0.000 dB

3.4.9 Number of Antenna Ports



This sets the number of antennas for the DUT.

It can be set when Test Model is Off. It is fixed to 1 when Test Model is not Off.

Procedure

 >  (Common Setting) >  (Reference Signal)
>  (Number of Antenna Ports)

or

 >  (Modulation Analysis) >  (Detail Settings)





Options 1, 2, 4
Default 1

3.4.10 Antenna Port



This sets the input signal antenna number.

It can be set when Test Model is Off. It is fixed to 0 when Test Model is not Off.

Procedure

 ^{Menu} >  (Common Setting) >  (Reference Signal)
>  (Antenna Port)

or

 >  (Modulation Analysis) >  (Detail Settings)

Options 0 to (Number of Antenna Ports –1)

Default 0

 3.4.9 Number of Antenna Ports

3.5 Setting Modulation Analysis

This section explains the measurement conditions for modulation analysis. Unless specifically excluded, calculation is performed using the same data without recapturing the input signal when parameters described in this section are changed after Single measurement ends and when the Storage Mode is Off.

3.5.1 Starting Subframe Number

This sets the subframe number for starting analysis based on the synchronized frame header.

Procedure

Measure > F1 (Modulation Analysis) > F1 (Analysis Time) > F1 (Starting Subframe Number)

or

Time/Stop > F1 (Starting Subframe Number)

Range

Table 3.5.1-1 Range of Starting Subframe Number

Uplink-downlink Configuration	Range
0	0, 5 + 10×N
1	0, 4, 5, 9 + 10×N
2	0, 3, 4, 5, 8, 9 + 10×N
3	0, 5, 6, 7, 8, 9 + 10×N
4	0, 4, 5, 6, 7, 8, 9 + 10×N
5	0, 3, 4, 5, 6, 7, 8, 9 + 10×N
6	0, 5, 9 + 10×N

Where N = 1 to 4

Default 0

Figure 3.5.1-1 shows the Downlink Subframe to be analyzed when Starting Subframe Number is 5, and Measurement Interval is 12. The analysis target at this time is 3 subframes, such as Subframe 5 of Frame 0, and subframe 0 and 5 of Frame 1.

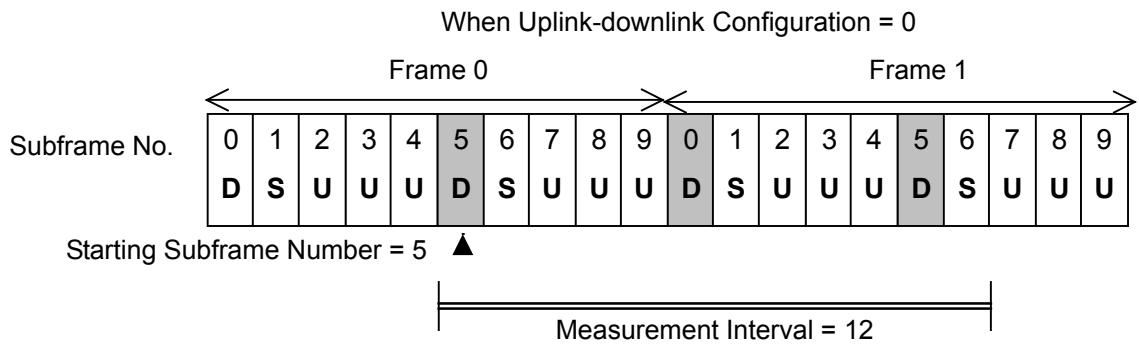

Figure 3.5.1-1 Setting Example for Uplink-downlink Configuration and Starting Subframe Number / Measurement Interval

3.5.2 Measurement Interval

This sets the analysis interval in subframe units. The value is set as the interval of contiguous subframes, irrespective of the subframe type.

The subframes for modulation analysis are the Downlink subframe and the Special subframe. The measurement results are unaffected even if the Uplink subframe count including the start to finish measurement interval is changed.

Figure 3.5.1-1 shows an example of setting the Measurement Interval to 12. The measurement results do not change at this time, because only the Uplink subframe is changed when Measurement Interval is between 12 and 15.

Procedure

Measure > F1 (Modulation Analysis) > F1 (Analysis Time) >
F2 (Measurement Interval)

or

TimeSweep > F2 (Measurement Interval)

Range	When Test Model Starting Frame Type is Unlock: 1 to (50 – Starting Subframe Number) Subframes When Test Model Starting Frame Type is Frame1 or Frame2: 1 to (40 – Starting Subframe Number) Subframes
Default	1 Subframes



3.5.3 PDSCH Modulation Scheme

This sets the modulation mode for the PDSCH.

The value of this parameter is applied to the entire measurement interval. As a result, PDSCH requires the same modulation method for all when QPSK, 16QAM, 64QAM, and 256QAM is selected.

It can be set when test model is Off. The setting is disabled when Test Model is not Off.

Procedure

 >  (Modulation Analysis) >
 (PDSCH Modulation Scheme)

Options

- QPSK Analyzes an input signal as a QPSK modulated signal.
- 16QAM Analyzes an input signal as a 16QAM modulated signal.
- 64QAM Analyzes an input signal as a 64QAM modulated signal.
- 256QAM Analyzes an input signal as a 256QAM modulated signal.
- AUTO Analyzes an input signal after judging its modulation scheme automatically (Excluding 256QAM) (Default).

Note:

If DwPTS is included in the measurement target, sometimes auto detection is not performed correctly because the PDSCH count included in DwPTS is too small. In this case, set any of QPSK, 16QAM, 64QAM, and 256QAM to the PDSCH Modulation Scheme matching the input signal.

3.5.4 Total EVM & Constellation Composite

This sets whether or not to display the Total EVM measurement results and Constellation graph for each channel (RS, PDSCH, PBCH, P-SS, S-SS, PDCCH, PCFICH, PHICH, DTX).

Procedure

Measure > F1 (Modulation Analysis) >
 F5 (Total EVM & Constellation Composite) >

Options	Include, Exclude	
Default	RS	Include
	PDSCH	Include
	PBCH	Include
	P-SS	Include
	S-SS	Include
	PDCCH	Include
	PCFICH	Include
	PHICH	Include
	DTX	Exclude

3.5.5 EVM Window Length

This sets the length of EVM Window applied to OFDM symbol as the width from the center position of Cyclic prefix. It can be set either as the FFT sample count W , or in T_s units (time per sample). Refer to Table 3.5.5-1 for the conversion method.

EVM Window is applied to OFDM symbol as shown in Fig. 3.5.5-1.

Assuming EVM Window Length is W , the EVM Window for the FFT size from the point (Cyclic prefix center $- W/2$) or (Cyclic prefix center $+ W/2$) is applied to OFDM symbol.

EVM Low indicates the measurement result when applying EVM Window from the point (Cyclic prefix center $- W/2$); EVM High indicates the measurement result when applying EVM Window from the point (Cyclic prefix center $+ W/2$). Finally, the EVM result is uses the larger of the larger of the EVM High and EVM Low values.

Note:

"Cyclic prefix center" actually indicates the next position.

At Cyclic prefix length 144 (OFDM symbol 1 to 6): FFT point 72

At Cyclic prefix length 160 (OFDM symbol 0: FFT point 88

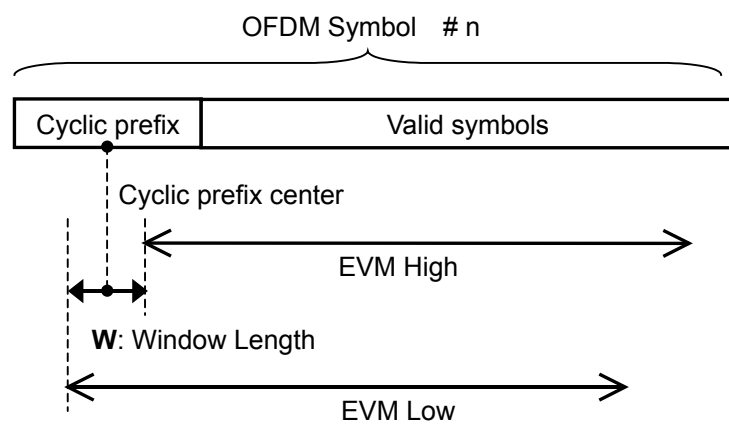

Figure 3.5.5-1 Window Length

Procedure

Measure > F1 (Modulation Analysis) > F6 (EVM Window Length)

Range

- Ts : 0 to 142
- W : When Channel Bandwidth is set to 1.4 MHz, 0 to 8
 When Channel Bandwidth is set to 3 MHz: 0 to 17
 When Channel Bandwidth is set to 5 MHz: 0 to 35
 When Channel Bandwidth is set to 10 MHz: 0 to 71
 When Channel Bandwidth is set to 15 MHz: 0 to 106
 When Channel Bandwidth is set to 20 MHz: 0 to 142

Default See Table 3.5.5-2.

Table 3.5.5-2 EVM Window Length Defaults and W/Ts Conversion

Channel Bandwidth	EVM Window Length (W)	W/Ts Conversion
1.4 MHz	5	×16
3 MHz	12	×8
5 MHz	32	×4
10 MHz	66	×2
15 MHz	102	× (2048/1536)
20 MHz	136	×1

3.5.6 PBCH - On / Off

This enables or disables the PBCH.

PBCH is arranged from the 8th to 11th symbol of Subframe 0.

This is supported when Test Model is set to Off. It is fixed to On when Test Model is set to not Off.

Procedure

Measure > F1 (Modulation Analysis) > F7 (Detail Settings)

- Range On (Check box selected) PBCH on
 Off (Check box not selected) PBCH off
- Default On



3.5.7 PBCH - Power Auto/Manual

This sets the method for determining the PBCH Boost level.

This is available when Test Model is set to Off. This is fixed to Manual when Test Model is not set to Off.

 3.5.9 Precautions at Power Auto Setting

Procedure

 >  (Modulation Analysis) >  (Detail Settings)

Options Auto, Manual

Default Auto



3.5.8 PBCH - Power Boosting

This sets the PBCH Boost level as a relative value based on the Reference Signal level.

The Power Auto/Manual setting is enabled at Manual.

It can be set when test model is Off. When Test Model is not Off, the defined value for Test Model is fixed.

Procedure

 >  (Modulation Analysis) >  (Detail Settings)

Range -20.000 dB to +20.000 dB

Default 0.000 dB

3.5.9 Precautions at Power Auto Setting

When the Power Auto/Manual setting for the physical channel/physical signal is Auto, this application determines the ideal signal for calculating the EVM based on the measured level. As a result, when there is a difference between the expected boost level and the actual signal level, sometimes this level difference is not reflected in the EVM result.

When the physical channel/physical signal Boost setting level is clear and is the same within the measurement interval, set that Boost level.

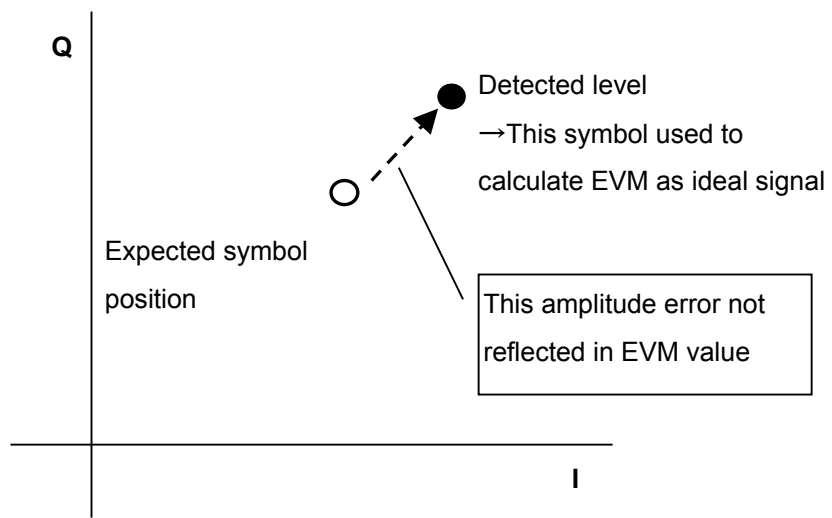

Figure 3.5.9-1 Determining Ideal Signal at Power Auto Setting

3.5.10 P-SS - On/Off

This enables/disables P-SS (Primary Synchronization Signal).

P-SS is arranged (aligned) at the 3rd symbol of Subframe 1 and 6.

This can be set when Synchronization Mode is set to Reference Signal. It is fixed to On when Synchronization Mode is set to Synchronization Signal.

Procedure

Measure > F1 (Modulation Analysis) > F7 (Detail Settings)

Range	On (Check box selected)	P-SS on
	Off (Check box not selected)	P-SS off
Default	On	

3.5.11 P-SS - Power Auto / Manual

This sets the method for determining the P-SS Boost level.

This is supported when Test Model is set to Off. This is fixed to Manual when Test Model is not set to Off.

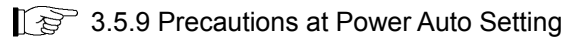

Procedure

> (Modulation Analysis) > (Detail Settings)

Options Auto, Manual

Default Auto

3.5.12 P-SS - Power Boosting

This sets the P-SS Boost level as a relative value based on the Reference Signal level.

The Power Auto/Manual setting is enabled at Manual.

This is supported when Test Model is set to Off. It is fixed to the value defined for Test Model when Test Model is not set to Off.

Procedure

> (Modulation Analysis) > (Detail Settings)

Range -20.000 dB to +20.000 dB

Default 0.000 dB

3.5.13 S-SS - On/Off

This enables/disables S-SS (Secondary Synchronization Signal).

S-SS is arranged (aligned) at the last symbol of Slot 0 (Subframe 0) and Slot 11 (Subframe 5).

This can be set when Synchronization Mode is set to Reference Signal. It is fixed to On when Synchronization Mode is set to Synchronization Signal.

Procedure

> (Modulation Analysis) > (Detail Settings)

Range On (Check box selected) S-SS on

Off (Check box not selected) S-SS off

Default On

3.5.14 S-SS - Power Auto/Manual

This sets the method for determining the S-SS Boost level.

This is supported when Test Model is set to Off. This is fixed to Manual when Test Model is not set to Off.

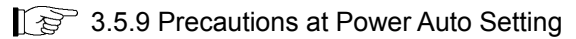

Procedure

> (Modulation Analysis) > (Detail Settings)

Options Auto, Manual

Default Auto

3.5.15 S-SS - Power Boosting

This sets the S-SS Boost level as a relative value based on the Reference Signal level.

The Power Auto/Manual setting is enabled at Manual.

This is supported when Test Model is set to Off. It is fixed to the value defined for Test Model when Test Model is not set to Off.

Procedure

> (Modulation Analysis) > (Detail Settings)

Range -20.000 dB to +20.000 dB

Default 0.000 dB

3.5.16 PDCCH - On / Off

This enables or disables the PDCCH.

PDCCH is arranged (aligned) as the OFDM symbol length determined by Number of PDCCH Symbols from the 0th OFDM symbol of each subframe (1st OFDM symbol only at Channel Bandwidth 1.4 MHz).

This is available when Test Model is set to Off. This is fixed to On when Test Model is not set to Off.

Procedure

> (Modulation Analysis) > (Detail Settings)

Range	On (Check box selected)	With PDCCH
	Off (Check box not selected)	Without PDCCH

Default On

3.5.17 PDCCH - Power Auto / Manual

This sets the method for determining the PDCCH Boost level.

This is available when Test Model is set to Off. This is fixed to Manual when Test Model is not set to Off.

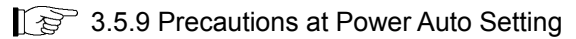

Procedure

Measure > F1 (Modulation Analysis) > F7 (Detail Settings)

Options Auto, Manual

Default Auto

3.5.18 PDCCH - Power Boosting

This sets the PDCCH Boost level as a relative value based on the Reference Signal level.

The Power Auto/Manual setting is enabled at Manual.

This is supported when Test Model is set to Off. It is fixed to the value defined for Test Model when Test Model is not set to Off.

Procedure

Measure > F1 (Modulation Analysis) > F7 (Detail Settings)

Range -20.000 to +20.000 dB

Default 0.000 dB

3.5.19 PCFICH - On/Off

This enables or disables the PCFICH.

PCFICH is arranged (aligned) at the header symbol of the Downlink subframe.

This is supported when Test Model is set to Off. This is fixed to On when Test Model is not set to Off.

Procedure

Measure > F1 (Modulation Analysis) > F7 (Detail Settings)

Range On (Check box selected) With PCFICH
Off (Check box not selected) Without PCFICH

Default On



3.5.20 PCFICH - Power Auto / Manual

This sets the method for determining the PCFICH Boost level.

This is supported when Test Model is set to Off. This is fixed to Manual when Test Model is not set to Off.

 3.5.9 Precautions at Power Auto Setting

Procedure

 >  (Modulation Analysis) >  (Detail Settings)

Options Auto, Manual

Default Auto



3.5.21 PCFICH - Power Boosting

This sets the PCFICH Boost level as a relative value based on the Reference Signal level.

The Power Auto/Manual setting is enabled at Manual.

This is supported when Test Model is set to Off. It is fixed to the value defined for Test Model when Test Model is not set to Off.

Procedure

 >  (Modulation Analysis) >  (Detail Settings)

Range -20.000 to +20.000 dB

Default 0.000 dB

3.5.22 PHICH - On / Off

This enables or disables the PHICH.

PHICH is arranged (aligned) at the head symbol of each Downlink subframe at Normal cyclic prefix.

There may be multiple instances of PHICH in the resource element(s) comprising the PHICH groups. PHICH is separated (differentiated, classified) according to the orthogonal sequence in PHICH group.

The number of PHICH groups included in 1 subframe is determined by the equation $m_i \bullet N_{PHICH}^{group}$. The values of N_{PHICH}^{group} and m_i are determined by the following equation and Table 3.5.22-1.

$$N_{PHICH}^{group} = \lceil N_g (N_{RB}^{DL} / 8) \rceil$$



Table 3.5.22-1 m_i Value

Uplink-downlink Configuration	Subframe No.i									
	0	1	2	3	4	5	6	7	8	9
0	2	1	-	-	-	2	1	-	-	-
1	0	1	-	-	1	0	1	-	-	1
2	0	0	-	1	0	0	0	-	1	0
3	1	0	-	-	-	0	0	0	1	1
4	0	0	-	-	0	0	0	0	1	1
5	0	0	-	0	0	0	0	0	1	0
6	1	1	-	-	-	1	1	-	-	1

 3.5. 28 PHICH - Ng

This is supported when Test Model is set to Off. This is fixed to On when Test Model is not set to Off.

Procedure

 >  (Modulation Analysis) >  (Detail Settings)

Range	On (Check box selected)	With PHICH
	Off (Check box not selected)	Without PHICH
Default	On	



3.5.23 PHICH - Power Auto / Manual

This sets the method for determining the PHICH Boost level.

This is supported when Test Model is set to Off. This is fixed to Manual when Test Model is not set to Off.

 3.5.9 Precautions at Power Auto Setting

Procedure

 >  (Modulation Analysis) >  (Detail Settings)

Options Auto, Manual

Default Auto



3.5.24 PHICH - Power Boosting

This sets the PHICH Boost level as relative value based on the Reference Signal level.

The Power Auto/Manual setting is enabled at Manual.

This is supported when Test Model is set to Off. It is fixed to the value defined for Test Model when Test Model is not set to Off.

Procedure

 >  (Modulation Analysis) >  (Detail Settings)

Range -20.000 to +20.000 dB

Default 0.000 dB

3.5.25 PDSCH - Power Auto / Manual



This sets the method for determining the PDSCH Boost level.

It can be set when test model is Off.

 3.5.3 PDSCH Modulation Scheme

 3.5.9 Precautions at Power Auto Setting

Procedure

 >  (Modulation Analysis) >  (Detail Settings)

Options Auto, Manual

Default Auto



3.5.26 PDSCH - Power Boosting

This sets the PDSCH Boost level as a relative value based on the Reference Signal level.

The above value is valid when Power is set to Manual.

It can be set when test model is Off. When Test Model is not Off, the defined value for Test Model is fixed.

Procedure

 >  (Modulation Analysis) >  (Detail Settings)

Range -20.000 to +20.000 dB

Default 0.000 dB

3.5.27 PHICH - TDD $m_i=1$ (E-TM) On/Off

This sets the m_i parameter, which is one parameter determining the PHICH group number.

This is supported when Test Model is set to Off. This is fixed to On when Test Model is not set to Off.

Procedure

Measure > F1 (Modulation Analysis) > F7 (Detail Settings)

Options	On(Check box selected)	The m_i parameter is set to 1 for all subframes.
	Off(Check box not selected)	The m_i parameter is set to a value defined in 3GPP TS36.211.

Default Off

3.5.28 PHICH - N_g

This sets the N_g parameter, which is one parameter determining the PHICH group number.

This is supported when Test Model is set to Off. This is fixed to 1/6 when Test Model is not set to Off.

Procedure

Measure > F1 (Modulation Analysis) > F7 (Detail Settings)

Options 1/6, 1/2, 1,2

Default 1/6

3.5.29 PHICH - Duration

This sets PHICH Duration.

It can be set when test model is Off. It is fixed to Normal when Test Model is not set to Off.

Procedure

Measure > F1 (Modulation Analysis) > F7 (Detail Settings)

Options Normal, Extended

Default Normal

3.5.30 Number of PDCCH Symbols - Auto/Manual

This selects automatic detection and manual setting of the number of OFDM symbols per PDCCH.

When Auto is set, the value is determined from the PCFICH decoded CFI (Control Format Indicator). CFI is information indicating the number of OFDM symbols per PDCCH and is transmitted by PCFICH.



This is enabled when both PDCCH and PCFICH are both on. When PCFICH is Off, the setting changes to Manual.

 3.5.16 PDCCH - On/Off

 3.5.19 PCFICH - On/Off

This is supported when Test Model is set to Off. It is fixed to Manual when Test Model is not set to Off.

Procedure

 >  (Modulation Analysis) >  (Detail Settings)

Options Auto, Manual

Default Auto

3.5.31 Number of PDCCH Symbols



This sets the number of OFDM symbols per PDCCH. There are two types of value: one for Subframe 1 and Subframe 6, and one for other subframes.

This is enabled when Number of PDCCH Symbols - Auto/Manual is set to Manual and PDCCH is set to On.

 3.5.16 PDCCH - On/Off

 3.5.30 Number of PDCCH Symbols - Auto/Manual

Procedure

 >  (Modulation Analysis) >  (Detail Settings)

Range	Subframe 1 and 6		
	Channel Bandwidth 1.4 MHz	:	2
	Channel Bandwidth not 1.4 MHz	:	1 to 2
	Other Subframes		
	Channel Bandwidth 1.4 MHz	:	2 to 4
	Channel Bandwidth not 1.4 MHz	:	1 to 3
Default	1		

3.5.32 PDCCH Mapping

This arranges PDCCH and NIL (Dummy PDCCH) in Control Channels Elements (CCEs).

This is enabled when PDCCH is set to On.

 3.5.16 PDCCH - On/Off

It can be set when test model is Off. When Test Model is not Off, the defined value for Test Model is fixed.

Procedure

 >  (Modulation Analysis) >  (Detail Settings)

Range	Auto, Easy
Default	Auto

3.5.33 PDCCH Format

This sets the PDCCH format. PDCCH format determines the CCE count supported by PDCCH.



This is enabled when PDCCH is enabled and PDCCH Mapping is set to Easy.

 3.5.16 PDCCH - On/Off

 3.5.32 PDCCH Mapping

This is supported when Test Model is set to Off. It is fixed to the value defined for Test Model when Test Model is not set to Off.

Procedure

 >  (Modulation Analysis) >  (Detail Settings)

Range 0 to 3

Default 0

3.5.34 Number of PDCCHs

This sets the PDCCH number included in 1 subframe.

The PDCCH arrangement (alignment) varies according to the PCFICH/PHICH arrangement (alignment). If the setting value for this parameter is larger than the arrangement (alignment) that can actually be set for PDCCH, the maximum value within this application is used.



This is enabled when PDCCH is enabled and PDCCH Mapping is set to Easy.

 3.5.16 PDCCH - On/Off

 3.5.32 PDCCH Mapping

This is supported when Test Model is set to Off. It is fixed to the value defined for Test Model when Test Model is not set to Off.

Procedure

 >  (Modulation Analysis) >  (Detail Settings)

Range 1 to 88



Default 1

3.5.35 Channel Estimation

This sets OFDM signal Channel Estimation processing On and Off.

When Channel Estimation is On, amplitude and phase estimation is performed based on the Reference Signal.

Procedure

 >  (Modulation Analysis) >  (Detail Settings)



Options On, Off

Default On

3.5.36 DwPTS

This sets whether or not to measure DwPTS.

Procedure

 >  (Modulation Analysis) >  (Detail Settings)

Range Include, Exclude

Default Exclude

3.5.37 PDSCH EVM Calculation

This specifies the PDSCH EVM Calculation target resource block. This parameter is applied only to the results for PDSCH ALL EVM, PDSCH QPSK EVM, PDSCH 16QAM, PDSCH 64QAM, and PDSCH 256QAM displayed in Summary.

Procedure

Measure > F1 (Modulation Analysis) > F7 (Detail Settings)

Range 3GPP, All PDSCH Resource Elements

3GPP

This is the measurement method defined by 3GPP. When Channel Bandwidth is 1.4 MHz, the calculation target is only 2 pairs of resource block including 138 resource elements. When Channel Bandwidth is not 1.4 MHz, the calculation target is only 2 pairs of resource blocks including 150 resource elements.

All PDSCH EVM Resource Elements

The calculation target is all resource elements allocated to PDSCH. The PDSCH EVM used in the Total EVM calculation is always calculated by this method.

Default 3GPP

3.5.38 Test Model Starting Frame Type

When the input signal is an E-UTRA Test Model (Test Model hereafter) defined by 3GPP TS36.141, Test Model is set. The Test Model signal E-TM1.2, 2, 2a, 3.2, and 3.3 are composed of frame1 and frame2. This function sets either frame 1 or frame 2 as the header frame for starting analysis. Select Unlock when specifying nothing.

Test Model is enabled only for E-TM1.2, E-TM2, E-TM2a, E-TM3.2, and E-TM3.3.

Procedure

Measure > F1 (Modulation Analysis) > F7 (Detail Settings)

Options UnLock, frame1, frame2



Default UnLock

3.5.39 Measurement Filter Type

This selects the type of filter used for signal analysis. Select Normal when using a single carrier. For a multicarrier signal, select Narrow to reduce the impact carriers not targeted for measurement.

Narrow is available when Extended Freq Lock Range is set to Off.

Procedure

 >  (Modulation Analysis) >  (Detail Settings)

Options Normal, Narrow



Default Normal

3.5.40 Extended Freq Lock Range

This function is for measuring signals with large frequency errors. Set to On to increase the measurable frequency error range.

On is enabled only when the Measurement Filter Type is Normal.

Procedure

 >  (Modulation Analysis) >  (Detail Settings)



Options Off, On

Default Off

3.5.41 Operating Detail Settings Dialog

The Detail Settings dialog box is opened using the following procedure.

Procedure

 >  (Modulation Analysis) >  (Detail Settings)

Inputting each parameter and pressing  (Set) uses the values for measurement.

When  (Restore Default Values) is pressed while the Detail Settings dialog box is displayed, the parameters displayed in the Detail Settings dialog box are returned to the same values as the defaults.

3.5.42 Analysis Frame Position

This sets the analysis start position in frame units. This setting is enabled when Capture Time is set to Manual. If Storage Mode is Off, the setting range is determined assuming Storage Count is 1.

If the value of Capture Time Length or Storage Count changes, Analysis Frame Position is automatically set to a value in the setting range.

Procedure

Measure > F1 (Modulation Analysis) > F1 (Analysis Time) > F7 (Analysis Frame Position)

or

TimeSweep > F7 (Analysis Frame Position)

Range 0 to (Capture Time Length – Storage Count×5) frames
 Default 0 frames

3.5.43 Analysis Offset Time

This sets the offset of the analysis start position in seconds based on Analysis Frame Position. This setting is enabled when Capture Time is set to Manual. If Storage Mode is Off, the setting range is determined assuming Storage Count is 1.

If the value of Capture Time Length, Storage Count, or Analysis Frame Position changes, Analysis Offset Time is automatically set to a value in the setting range.

Procedure

Measure > F1 (Modulation Analysis) > F1 (Analysis Time) > F8 (Analysis Offset Time)

Or

TimeSweep > F8 (Analysis Offset Time)

Range

When Capture Time Length = 5: 0 s (fixed)
 If Capture Time Length > 5 and
 Analysis Frame Position = 0 0 to +4999999 ns
 If Analysis Frame Position = Capture Time Length - 5
 -49999990 to 0 ns
 If Analysis Frame Position is other than the above
 -49999990 to +4999999 ns

Default 0 s

3.6 Modulation Analysis Measurement and Results

Modulation analysis is applied to a maximum of five frame intervals according to the Uplink-downlink Configuration, Starting Subframe Number, and Measurement Interval settings.

Unless otherwise described, the target measurement interval per modulation analysis is the averaged value for the Measurement Interval from Starting Subframe Number based on the synchronized frame header.

Modulation analysis measurement is performed as described below.

Procedure

1. Set frequency, level and trigger.

 3.2 Setting Frequency and Level

 3.3 Setting Trigger

2. Set system parameters.

 3.4 Common Settings

3. Press  >  (Modulation Analysis).

4. Set modulation analysis related parameters.

 3.5 Setting Modulation Analysis

5. Set Storage-related parameters.

 3.6.1 Setting Storage Mode/Count

6. Measure.

 3.1.3 Performing Measurement

7. Select display contents.

 3.6.2 Trace Mode

 3.6.3 Frame Offset

 3.6.5 Setting EVM Display Units and Scale

 3.6.15 Marker

3.6.1 Setting Storage Mode/Count

The Storage (Averaging) setting can be set when Trace Mode is not set to Power vs RB and EVM vs RB.

This setting is disabled when Capture Time is set to Manual and when Capture Time Length is set to 5.

Storage Mode

This enables Storage (Averaging) and the display method.

Procedure

 >  (Storage) >  (Mode)

Options	Off	Storage off
	Average	Display average
	Average & Max	Display average and max.
Default	Off	

Storage Count

This sets the Storage count (number of averaging).

Procedure

 >  (Storage) >  (Count)

Range

When Capture Time is Auto: 2 to 9999

When Capture Time is set to Manual: 2 to Capture Time Length / 5

Default 10

3.6.2 Trace Mode

Modulation analysis has six trace types (display modes) as listed below.

(1) EVM vs Subcarrier

This displays the main numeric results, such as IQ constellation, frequency error, transmission power, EVM, etc., for each OFDM symbol, as well as the EVM graph for each Subcarrier.

(2) EVM vs Symbol

This displays the main numeric results, such as IQ constellation, frequency error, transmission power, EVM, etc., for each OFDM symbol, as well as the EVM graph for each OFDM symbol.

(3) Spectral Flatness

This displays the main numeric results, such as IQ constellation, frequency error, transmission power, EVM, etc., for each OFDM symbol, as well as a graph for Spectral Flatness. The type of graph varies with the Spectral Flatness Type.

(4) Power vs RB

This displays the main numeric results, such as IQ constellation, frequency error, transmission power, EVM, etc., for each PDSCH resource element as well as a graph of the PDSCH power per resource block.

(5) EVM vs RB

This displays the main numeric results, such as IQ constellation, frequency error, transmission power, EVM, etc., for each PDSCH resource element, as well as the PDSCH EVM graph per resource block.

(6) Summary

This displays the main numeric results, such as frequency error, transmission power, EVN, etc. The display contents change according to the Page Number.

(7) Test Model Summary

When Test Model is not set to Off, the measurement results for the Test Model signal are displayed.

Procedure

 >  (Trace Mode)

Options EVM vs Subcarrier, EVM vs Symbol, Spectral Flatness, Power vs RB, EVM vs RB, Summary Test Model Summary

Default EVM vs Subcarrier

3.6.3 Frame Offset

This displays the results for each trace constellation and graph in 1 frame units.

When the analysis target crosses several frames, set the Frame Offset and display frame interval.

In Figure 3.5.1-1, set Frame Offset to 1 to display the Frame 1 interval.

This parameter is not displayed when Trace Mode is set to Summary.

Procedure

 >  (Frame)

Range 0 to 4

Default 0

3.6.4 Main Numeric Results

The main numeric results of modulation analysis are listed below.

(1) Frequency Error [Hz] / [ppm]

This is the difference between the set Carrier Frequency value and the carrier frequency of the input signal specified from the measurement interval Reference Signal. The maximum value is determined by comparing the absolute value of each measurement result.

(2) Output Power [dBm]

This is the average power of the 31.25 MHz band centered on the set Carrier Frequency. It also includes the Cyclic prefix at the measurement target OFDM symbol.

(3) Mean Power [dBm]

This is the average power of the Channel Bandwidth set bandwidth centered on the set Carrier Frequency. It also includes the Cyclic prefix at the measurement target OFDM symbol.

(4) EVM (rms) [%] / [dB]

This is the average value of the EVM for all physical channels and physical signals set at Include at Total EVM Calculation. The larger value determined by comparing the Total EVM High and Total EVM Low for one measurement interval is used.

(5) EVM (peak) [%] / [dB]

This displays the maximum EVM in all Subcarriers and symbols for all physical channels and physical signals set at Include at Total EVM Calculation.



(6) Time Offset [ns]

This displays the time offset between the frame header and trigger. It is displayed only when Trigger Switch is set to On.

3.6.5 Setting EVM Display Units and Scale

The EVM units can be switched between % and dB using the EVM Unit setting.

Procedure

 >  (Scale) >  (EVM Unit)

Options %, dB

Default %

3.6.6 Constellation

The IQ constellation is displayed at the left side of the screen when the Trace Mode is EVM vs Subcarrier, EVM vs Symbol, or Spectral Flatness

The display object is all subcarriers at the OFDM symbol set by Constellation Symbol Number for the frame specified by Frame Offset.

Nothing is displayed at Constellation when the Constellation Symbol Number is Downlink Subframe and the OFDM symbol is not DwPTS.

Constellation Symbol Number

Constellation Symbol Number is the number of the OFDM symbol displayed in Constellation. It is set as the continuous count from the frame header (0) to the last frame.

Procedure

 >  (Constellation Symbol Number)

Range 0 to 139

Default 0

Constellation Display Range

Select either Symbol or Composite (Frame units) for the Constellation Graph.

Procedure

 >  (Constellation Display Range)

Options Symbol, Composite

Default Symbol

3.6.7 EVM vs Subcarrier

This displays a graph at the bottom of the screen of the EVM for each subcarrier in the frame specified by Frame Offset when Trace Mode is EVM vs Subcarrier.

EVM vs Subcarrier View

This graph displays the averaged EVM value for OFDM symbols included in the Downlink Subframe for analysis when EVM vs Subcarrier View is set to Averaged over all Symbols. Depending on Graph View, the displayed data can be set to either RMS EVM only or to both RMS EVM and Peak EVM.

When EVM vs Subcarrier View is set to Each Symbol, the graph displays the EVM for OFDM symbols specified by Bottom Graph Symbol Number.

Procedure

 >  (EVM vs Subcarrier View)

Options Each Symbol, Averaged over all Symbols
 Default Averaged over all Symbols

Graph View

This sets the type of EVM displayed in the graph.

Procedure

 >  (EVM vs Subcarrier View) >  (Graph View)

Options RMS, RMS&Peak
 Default RMS&Peak

Bottom Graph Symbol Number

This is the number of the OFDM symbol displayed in the graph. It is set as the continuous count from the frame header (0) to the last frame and is enabled only when EVM vs Subcarrier View is set to Each Symbol.

Procedure



 >  (Bottom Graph Symbol Number)

Range 0 to 139
 Default 0

EVM Scale

This sets the maximum value of the graph y-axis (EVM).

Procedure

 >  (Scale) >  (EVM Scale)

Range	when EVM Unit is %	2%, 5%, 10%, 20%
	when EVM Unit is dB	0 dB, -20 dB, -40 dB
Default	when EVM Unit is %	5%
	when EVM Unit is dB	-40 dB

Marker Results (MKR)

This displays the EVM at the subcarrier selected by the marker.

3.6.8 EVM vs Symbol

This displays a graph of the EVM for the OFDM symbols in the frame specified by Frame Offset at the bottom of the screen when Trace Mode is EVM vs Symbol.

EVM vs Symbol View

This graph displays the averaged EVM value for the subcarrier included in the Downlink Subframe for analysis when EVM vs Symbol View is set to Averaged over all Subcarriers. Depending on Graph View, the displayed data can be set to either RMS EVM only or to both RMS EVM and Peak EVM.

When EVM vs Subcarrier View is set to Each Subcarrier, the graph displays the EVM for the subcarrier set at Subcarrier Number.

Procedure



 >  (EVM vs Symbol View)

Options Each Subcarrier, Averaged over all Subcarriers
 Default Averaged over all Subcarriers

Graph View

This sets the type of EVM displayed in the graph.

Procedure



 >  (EVM vs Symbol View) >  (Graph View)

Options RMS, RMS&Peak
 Default RMS&Peak

Subcarrier Number

Subcarrier Number is the number of the subcarrier displayed in the graph. It is only enabled when EVM vs Symbol View is set to Each Subcarrier.

Procedure

 >  (Subcarrier Number)

Range



Channel Bandwidth 1.4 MHz	0 to 71
Channel Bandwidth 3 MHz	0 to 179
Channel Bandwidth 5 MHz	0 to 299
Channel Bandwidth 10 MHz	0 to 599
Channel Bandwidth 15 MHz	0 to 899
Channel Bandwidth 20 MHz	0 to 1199

Default 0

EVM Scale

This sets the maximum value of the graph y-axis (EVM).

Procedure

 >  (Scale) >  (EVM Scale)

Range	when EVM Unit is %	2%, 5%, 10%, 20%
	when EVM Unit is dB	0 dB, -20 dB, -40 dB
Default	when EVM Unit is %	5%
	when EVM Unit is dB	-40 dB

Marker Results (MKR)

This displays the EVM at the OFDM symbol selected by the marker.

3.6.9 Spectral Flatness

This displays a graph of the Spectral Flatness for the OFDM symbols included in the Downlink Subframe for analysis in the frame specified by Frame Offset at the bottom of the screen when Trace Mode is set to Spectral Flatness.

There are four types of Spectral Flatness graph that are set by Spectral Flatness Type.

(1) Amplitude vs Subcarrier

This displays the relative power of each subcarrier versus the average power of all valid Subcarriers.

(2) Difference Amplitude vs Subcarrier

This displays the difference in power between adjacent Subcarriers.

(3) Phase vs Subcarrier



This displays the phase error of each subcarrier.

(4) Group Delay

This displays the group delay of adjacent Subcarriers.

Spectral Flatness Type

Procedure

 >  (Spectral Flatness Type)



Options Amplitude, Difference Amplitude, Phase, Group Delay

Default Amplitude

Flatness Scale

This sets the display range for the y-axis of the graph.

Procedure

 >  (Scale) >  (Flatness Scale)

Range

Amplitude	±1 dB, ±3 dB, ±10 dB
Difference Amplitude	±0.1 dB, ±0.3 dB, ±1 dB
Phase	±1 degree, ±3 degree, ±60 degree
Group	±1 ns, ±10 ns, ±50 ns, ±100 ns

Default

Amplitude	±0 dB
Difference Amplitude	±1 dB
Phase	±60 degree
Group	±100 ns

Marker Results (MKR)

The value for the subcarrier selected by the marker is displayed according to the graph type.

3.6.10 PDSCH Constellation

This displays the PDSCH IQ constellation at the bottom of the screen when Trace Mode is set to Power vs RB, and EVM vs RB.

The display target is PDSCH at the resource block specified by Subframe Number and Resource Block Number in the frame specified by Frame Offset.

The constellation is not displayed when Subframe Number is at the Uplink Subframe position.



Marker Results (MKR)

The subcarrier for the symbol at the resource element selected by the marker, OFDM symbol, subframe, resource block and IQ coordinates are displayed.

3.6.11 Subframe Number

This sets the subframe for display in the PDSCH constellation when Trace Mode is Power vs RB and EVM vs RB.

Procedure

 >  (Subframe Number)

Range 0 to 9

Default 0



3.6.12 Resource Block Number

This sets the resource block for display in the PDSCH constellation when Trace Mode is Power vs RB and EVM vs RB.

Note:

The definition of the resource block parameter used by Power vs RB and EVM vs RB is the set of 12 subcarriers and 14 OFDM symbols (2 slots).

Procedure

 >  (Resource Block Number)

Range

Channel Bandwidth 1.4 MHz	0 to 5
Channel Bandwidth 3 MHz	0 to 14
Channel Bandwidth 5 MHz	0 to 24
Channel Bandwidth 10 MHz	0 to 49
Channel Bandwidth 15 MHz	0 to 74
Channel Bandwidth 20 MHz	0 to 99
Default	0

3.6.13 Power vs RB

This displays a graph of the PDSCH average power in the frame specified by Frame Offset at the bottom of the screen when Trace Mode is set to Power vs RB.

Power vs RB View

When Power vs RB View is set to Overall, the graph displays the PDSCH power distribution with subframe and resource block as the graph axes. The size of the power is displayed using colors on the right side of the graph.

When EVM vs Symbol View is set to Each Subframe, the graph displays the power vs resource block for the subframe specified by Subcarrier Number.

Procedure

 >  (Power vs RB View)

Options Each Subframe, Overall
 Default Overall

Graph View

This sets the type of EVM displayed in the graph.

Procedure

 >  (Power vs RB View) >  (Graph View)

Options RMS, RMS&Peak
 Default RMS&Peak

Marker Results (MKR)

The modulation method for the resource block specified by the marker, average power (relative value of absolute power vs Reference Signal average power) and EVM are displayed.

3.6.14 EVM vs RB

This displays a graph of the PDSCH EVM vs resource block in the frame specified by Frame Offset at the bottom of the screen when Trace Mode is set to EVM vs RB.

Graph View

This sets the type of EVM displayed in the graph.

Procedure

 >  (Graph View)



Options RMS, RMS&Peak

Default RMS&Peak

EVM Scale

This sets the maximum value of the graph y-axis (EVM).

Procedure

 >  (Scale) >  (EVM Scale)

Range when EVM Unit is % 2%, 5%, 10%, 20%
 when EVM Unit is dB 0 dB, -20 dB, -40 dB

Default when EVM Unit is % 5%
 when EVM Unit is dB -40 dB

Marker Results (MKR)

The PDSCH modulation method for the selected resource block, average power (relative to Reference Signal average power) and EVM are displayed.

3.6.15 Marker

This displays markers in the constellation at the top left of the screen and in the graph at the bottom of the screen.

Procedure



or



The procedure for using is explained below.

Marker

This sets marker display/non-display.

Procedure



Options On, Off

Default On

Constellation Marker Number - Subcarrier

This sets markers in subcarrier units at the constellation displayed when Trace Mode is set to EVM vs Subcarrier, EVM vs Symbol, and Spectral Flatness.

Procedure

1. > (Constellation Select)
2. (Constellation Marker Number)

Range



Channel Bandwidth 1.4 MHz	0 to 71
Channel Bandwidth 3 MHz	0 to 179
Channel Bandwidth 5 MHz	0 to 299
Channel Bandwidth 10 MHz	0 to 599
Channel Bandwidth 15 MHz	0 to 899
Channel Bandwidth 20 MHz	0 to 1199

Default 0

Constellation Marker Number - Resource Element

This sets markers in PDSCH resource element units at the constellation displayed when Trace Mode is set to Power vs RB, and EVM vs RB.

Procedure

 >  (Constellation Marker Number)



Range Number of resource elements detected as 0 to PDSCH

Default 0

Bottom Graph Marker Number - Subcarrier

This sets markers in subcarrier units at the graph displayed when Trace Mode is EVM vs Subcarrier, and Spectral Flatness.

Procedure

1.  >  (Bottom Graph Select)

2.  (Bottom Graph Marker Number)

Range

Difference Amplitude and Group Delay of Spectral Flatness

- Channel Bandwidth 1.4 MHz 1 to 70
- Channel Bandwidth 3 MHz 1 to 178
- Channel Bandwidth 5 MHz 1 to 298
- Channel Bandwidth 10 MHz 1 to 598
- Channel Bandwidth 15 MHz 1 to 898
- Channel Bandwidth 20 MHz 1 to 1198

Except Above



- Channel Bandwidth 1.4 MHz 0 to 71
- Channel Bandwidth 3 MHz 0 to 179
- Channel Bandwidth 5 MHz 0 to 299
- Channel Bandwidth 10 MHz 0 to 599
- Channel Bandwidth 15 MHz 0 to 899
- Channel Bandwidth 20 MHz 0 to 1199

Default 0

Bottom Marker Number - Symbol

This sets markers in OFDM symbol units at the graph displayed when Trace Mode is set to EVM vs Symbol.

Procedure

1.  >  (Bottom Graph Select)
2.  (Bottom Graph Marker Number)

Range 0 to 139

Default 0

Peak Search / Next Peak / Dip Search / Next Dip

These functions move markers to the maximum (Peak) and minimum (Dip) points on the graph displayed at the bottom of the screen. Next Peak and Next Dip move the markers to the next point based on the current marker positions.

Procedure



or

 >  (Page 2)



3.6.16 Summary

When the Trace Mode is set to Summary, this displays the numeric results on the multiple pages at the bottom of the screen. The pages are switched using Page Number.

Page Number

This switches the type of results displayed in Summary.

Procedure

 >  (Page Number)

Range 1 to 17

Default 1

The following types of results are displayed in Summary.

Screen Top (always displayed)

- (1) Symbol Clock Error [ppm]

This is the Symbol Clock Error.

Refer to section 3.6.4 Main Numeric Results for results other than the above.

 3.6.4 Main Numeric Results

Page 1: List of EVM and Power for Each Channel

This is the averaged EVM and Power in the analyzed interval. The target is all physical channels and physical signals set by Include at Total EVM Calculation and DwPTS.

Page 2: Total EVM

This is the averaged EVM is the analysis interval. The target is all physical channels and physical signals set by Include at Total EVM Calculation and DwPTS.

Page 3: PDSCH ALL EVM

This is the averaged EVM is the analysis interval. The target is all QPSK, 16QAM, 64QAM and 256QAM-modulated PDSCH.

Page 4: PDSCH QPSK EVM

This is the averaged EVM is the analysis interval. The target is PDSCH modulated by QPSK.

Page 5: PDSCH 16QAM EVM

This is the averaged EVM is the analysis interval. The target is PDSCH modulated by 16QAM.

Page 6: PDSCH 64QAM EVM

This is the averaged EVM in the analysis interval. The target is PDSCH modulated by 64QAM.

Page 7: PDSCH 256QAM EVM

This is the averaged EVM in the analysis interval. The target is PDSCH modulated by 256QAM.

Page 8: PDCCH EVM

This is the averaged EVM in the analysis interval. The target is PDCCH.

Page 9: RS EVM

This is the averaged EVM in the analysis interval. The target is the Reference Signal.

Page 10: P-SS EVM

This is the averaged EVM in the analysis interval. The target is the Primary Synchronization Signal.

Page 11: S-SS EVM

This is the averaged EVM in the analysis interval. The target is the Secondary Synchronization Signal.

Page 12: PBCH EVM

This is the averaged EVM in the analysis interval. The target is PBCH.

Page 13: PCFICH EVM

This is the averaged EVM in the analysis interval. The target is PCFICH.

Page 14: PHICH EVM

This is the averaged EVM in the analysis interval. The target is PHICH.

Page 15: Power vs Slot

This is the slot power in the analysis interval. If the analysis target crosses several frames, it is the averaged value at the same position in slots of different frames.

Page 16 : Channel Power, and others

This is the average power of each physical channel and physical signal in the analysis interval.

(1) RS Power [dBm]

This is the average power of the Reference Signal.

(2) P-SS Power [dBm] / [dB]

This displays the average power of the Primary Synchronization Signal as the absolute value and value relative to RS Power.

(3) S-SS Power [dBm] / [dB]

This displays the average power of the Secondary Synchronization Signal as the absolute value and value relative to RS Power.

(4) PBCH Power [dBm] / [dB]

This displays the average power of PBCH as the absolute value and value relative to RS Power.

(5) PDCCH Power [dBm] / [dB]

This displays the average power of PDCCH as the absolute value and value relative to RS Power.

(6) PCFICH Power [dBm] / [dB]

This displays the average power of PCFICH as the absolute value and value relative to RS Power.

(7) PHICH Group Power [dBm] / [dB]

This displays the average power of PHICH Group as the absolute value and value relative to RS Power.

(8) Cell ID

This is the Cell ID of the input signal. It is detected from Synchronization Signal of the input signal when Synchronization Mode is set to SS. The value of Cell ID set by the parameter when Synchronization Mode is set to Reference Signal is displayed.

(9) Number of PDCCH Symbols (Subframe 1 and 6)
Number of PDCCH Symbols (Other Subframes)

This is the number of symbols forming PDCCH of the input signal. It is detected from CFI of PCFICH when Number of PDCCH Symbols is set to Auto. The value of Number of PDCCH symbols set by the parameter when Number of PDCCH Symbols is set to Auto is displayed.

Page 17: RS Power and OFDM Symbol Tx Power

This is the Reference Signal Power and OFDM Symbol TX Power (OSTP) for each subframe in the analysis interval. If the analysis target crosses several frames, it is the averaged value at the same subframe position of different frames.

OFDM Symbol Tx Power is the total of all subcarrier powers at the fourth OFDM symbol included only in PDSCH of the subframe.

3.6.17 Test Model Summary

When the Trace Mode is set to Test Model Summary, this displays the numeric results on the multiple pages at the bottom of the screen. The pages are switched using Page Number.

Page Number

This switches the type of results displayed in Test Model Summary.

Procedure

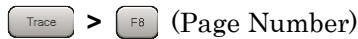

Range 1 to 10

Default 1

The following types of results are displayed in Test Model Summary.

Screen Top (Always displayed)

Refer to 3.6.4 “Main Numeric Results” for the results at the screen top.



Page 1, 2: Frame Type/RS boosting value per subframe

Either Frame Type or RS boosting is displayed for the Subframe setting interval of Measurement Interval starting from the position specified at Starting Subframe. When the Measurement Interval is 20 or more, the result for 20Subframe is displayed.

Page 3, 4: EPRE/Ers value per subframe

The EPRE/Ers value for each channel is displayed for the Subframe setting interval of Measurement Interval starting from the position specified at Starting Subframe.

Page 5, 6 : EPRE/Ers value for PDSCH per subframe

The EPRE/Ers value for each modulation method/boosting value of PDSCH is displayed for the Subframe setting interval of Measurement Interval starting from the position specified at Starting Subframe.

Page 7 : EVM value for each channel per frame1/frame2

The EVM value for each channel is displayed per frame1/frame2 for the analysis section specified at Measurement Interval.

This is enabled only when Test Model is E-TM1.2, E-TM2a, E-TM2, E-TM3.2 or E-TM3.3.

Page 8 : Power value for each slot per frame1/frame2

The power value for each slot is displayed per frame1/frame2 for the analysis section specified at Measurement Interval.

This is enabled only when Test Model is E-TM1.2, E-TM2, E-TM2a, E-TM3.2 or E-TM3.3.

Page 9 : RS Power value for each slot per frame1/frame2

The RS power value for each slot is displayed per frame1/frame2 for the analysis section specified at Measurement Interval.

This is enabled only when Test Model is E-TM1.2, E-TM2, E-TM2a, E-TM3.2 or E-TM3.3.

Page 10 : OSTP value for each slot per frame1/frame2

The OSTP value for each slot is displayed per frame1/frame2 for the analysis section specified at Measurement Interval.

This is enabled only when Test Model is E-TM1.2, E-TM2, E-TM2a, E-TM3.2 or E-TM3.3.

3.7 Power vs Time Setting

The Power vs Time function displays the time fluctuations of power of the measured signal to perform the mask judgment.

Notes:

- The replay function cannot be used.
- The power of the measured signal in the On interval is from -30 dBm to $+30$ dBm when Pre-Amp Mode is Off. On the other hand, when Pre-Amp Mode is On, set it from -30 dBm to $+10$ dBm (Peak value).

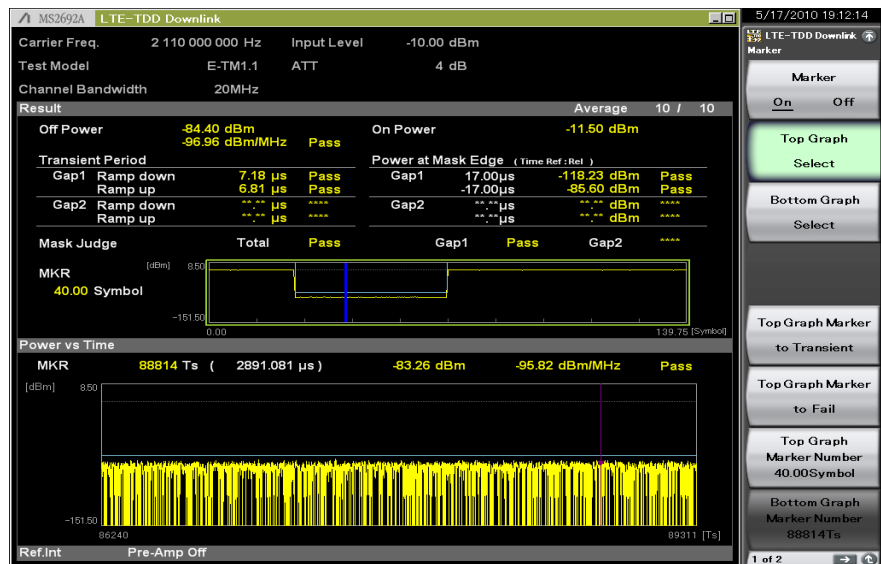





Figure 3.7-1 Power vs Time Setting Screen

3.7.1 Wide Dynamic Range

This sets whether to enable or disable Wide Dynamic Range.

When Wide Dynamic Range is set to On, the measurement parameter is changed internally at the Off Power measurement to improve the measurement accuracy.

Procedure

 >  (Power vs Time) >  (Wide Dynamic Range)

Options On (Enabled), Off (Disabled)

Default Off

When Wide Dynamic Range is set to On, Pre-Amp is switched to Off forcefully.



If the measurement function is changed from Power vs Time to the other one, Wide Dynamic Range is switched to Off.

 3.2.4 Pre-Amp

3.7.2 Noise Correction

This sets whether to perform the noise correction.

Procedure

 >  (Power vs Time) >  (Noise Correction)

Options On (Enabled), Off (Disabled)

Default Off

Noise Correction can be set only when Wide Dynamic Range is set to On.

When Wide Dynamic Range is set to Off, the Noise Correction menu is displayed in gray and the function is disabled.

When Limiter Mode is On, Both Noise Correction and Pre-Amp Mode can be set to On at the same time.



When Limiter Mode is Off, Both Noise Correction and Pre-Amp Mode cannot be set to On at the same time.

If the measurement function is changed from Power vs Time to the other one, Noise Correction is switched to Off.

3.7.3 Pre-Amp Mode

This sets whether to use Pre-Amp at the Off power measurement.

Procedure

 >  (Power vs Time) >  (Pre-Amp Mode)

Options On (Enabled), Off (Disabled)

Default Off

This can be set only when Wide Dynamic Range is On and Trigger Switch is On.

When Wide Dynamic Range or Trigger Switch is set to Off, the Pre-Amp Mode menu is displayed in gray and the function is disabled.

When Limiter Mode is On, Both Noise Correction and Pre-Amp Mode can be set to On at the same time.

When Limiter Mode is Off, Both Noise Correction and Pre-Amp Mode cannot be set to On at the same time.

When Pre-Amp Mode is On, input the trigger.

If the measurement function is changed from Power vs Time to the other one, Pre-Amp Mode is switched to Off.

Note:

When the option 008 is not enabled, the Pre-Amp menu is not displayed.

3.7.4 Channel bandwidth



Refer to Section 3.4.1 Channel Bandwidth.

3.7.5 Setting smoothing (Smoothing)

Smoothing

This sets whether to perform the smoothing for the waveform.

Procedure

 >  (Smoothing) >  (Smoothing)



Options On, Off

Default On

Smoothing Length

This sets the smoothing length (time).

Procedure

 >  (Smoothing) >  (Smoothing Length)

Range 1 to 2151 Ts



Default 2151

Resolution 1

Smoothing Range

This sets the smoothing range.

Procedure

 >  (Smoothing) >  (Smoothing Range)

Options

Mask Only between the Mask lines set by Mask Setup

Entire Entire waveform

Default Mask

 3.7.7 Mask Setup

3.7.6 Select Mask

This selects the Mask line.

Procedure

Measure > F2 (Power vs Time) > F5 (Select Mask)

Options

Standard	Uses Mask line defined by 3GPP
User	Uses Mask line set by user
Default	Standard

3.7.7 Mask Setup

This sets the setting method of the Mask line.

Procedure

Measure > F2 (Power vs Time) > F6 (Mask Setup)

Gap

This selects Gap to be set.

Procedure

Measure > F2 (Power vs Time) > F6 (Mask Setup) >
F1 (Gap)

Options	1,2
Default	1

When Uplink-downlink Configuration is 3, 4, or 5, Gap2 cannot be used.

 3.1.4 Measurement Signals and Troubleshooting Errors

The Downlink subframe is defined depending on the Uplink-downlink Configuration settings (see Table 3.4.4-1).

At this time, GP and UpPTS in Uplink and Special subframes become Off sections in which there is no signal output.

Depending on the Uplink-downlink Configuration setting, there can be one or two Off sections in a frame.

Mask Setup sets a mask line in each Off section (Gap1, Gap2).

Start Time

This sets Start Time on the Mask line.

Procedure

 >
  (Power vs Time) >
  (Mask Setup) >
  (Start Time)

Range

Time Reference = Abs.(Both Gap1 and 2)
0 to 10 ms

Time Reference = Rel.

Setting Range		GAP1
U/D Config*1	SS Config*2	Start Time[ms]
0,1,2,3,4,5,6	0,5	-1.21458 to 8.78542
	1,6	-1.64323 to 8.35677
	2,7	-1.71458 to 8.28542
	3,8	-1.78594 to 8.21406
	4	-1.85729 to 8.14271
Setting Range		GAP2
U/D Config	SS Config	Start Time[ms]
0,1,2,6	0,5	-6.21458 to 3.78542
	1,6	-6.64323 to 3.35677
	2,7	-6.71458 to 3.28542
	3,8	-6.78594 to 3.21406
	4	-6.85729 to 3.14271

*1: U/D Configuration

 3.4.4 Uplink-downlink Configuration

*2: SS Configuration

 3.4.5 Special Subframe Configuration

Default

52.00 μ s (When U/D Config is 3, SS Config is 8 and Time Reference is Relative)

Stop Time

This sets Stop Time on the Mask line.

Procedure

Measure > F2 (Power vs Time) > F6 (Mask Setup) > F3 (Stop Time)

Range

Time Reference = Abs. (Both Gap1 and 2)
0 to 10 ms

Time Reference = Rel.

Setting Range	GAP1
U/D Config	Stop Time[ms]
0	-5.00000 to 5.00000
1	-4.00000 to 6.00000
2	-3.00000 to 7.00000
3	-5.00000 to 5.00000
4	-4.00000 to 6.00000
5	-3.00000 to 7.00000
6	-5.00000 to 5.00000
Setting Range	GAP2
U/D Config	Stop Time[ms]
0	-10.00000 to 0.00000
1	-9.00000 to 1.00000
2	-8.00000 to 2.00000
3	—
4	—
5	—
6	-9.00000 to 1.00000

Default

-52.00 μs (When U/D Config is 3, SS Config is 8 and Time Reference is Relative)

Time Reference

This selects the reference time to be set when setting Start Time and Stop Time.

Select the reference time when setting Start Time and Stop Time.

Procedure

Measure > F2 (Power vs Time) > F6 (Mask Setup) >
F4 (Time Reference)

Options

- Abs. Sets absolute time from 0 header of Subframe0
- Rel. Sets relative time using boundary of On/Off switching of signal calculated from Uplink-downlink Configuration and Special Subframe Configuration setting as reference time

Default Rel.

Off Power Limit

This sets the Off origin of Mask rise and fall.

Procedure

Measure > F2 (Power vs Time) > F6 (Mask Setup) >
F5 (Off Power Limit)

Range -110.00 to -40.00 dBm/MHz

Default -85.00 dBm/MHz

Load Standard setting

This sets same value at Mask Setup as when Select Mask is set to Standard.

Procedure

Measure > F2 (Power vs Time) > F6 (Mask Setup) > F6 (Load Standard Setting)

The applied values are as shown below.

Start Time

Time Reference = Abs.

Default		GAP1	Default		GAP2
U/D Config	SS Config	Start Time[ms]	U/D Config	SS Config	Start Time[ms]
0,1, 2,3, 4,5, 6	0,5	1.23158	0,1,2 ,6	0,5	6.23158
	1,6	1.66023		1,6	6.66023
	2,7	1.73158		2,7	6.73158
	3,8	1.80294		3,8	6.80294
	4	1.87429		4	6.87429

Time Reference = Rel. (Both Gap1 and 2)
52.00 μs

Stop Time

Time Reference = Abs.

Default	GAP1	GAP2
U/D Config	Stop Time[ms]	Stop Time[ms]
0	4.983	9.983
1	3.983	8.983
2	2.983	7.983
3	4.983	-
4	3.983	-
5	2.983	-
6	4.983	8.983

Time Reference = Rel. (Both Gap1 and 2)
-52.00 μs

3.7.8 Frame Sync

This sets whether to perform frame synchronization by modulation analysis. If this function is set to Off, Power vs Time measurement is performed in synchronization with a trigger signal, without performing frame synchronization by modulation analysis.

If Trigger Switch is set to Off, this function is fixed to On.

If Limiter Mode is set to On, this function is fixed to Off.

This function is displayed in the Detail Settings dialog box for Power vs Time measurement.

Procedure

 >  (Power vs Time) >  (Detail Settings)

Options Off, On

Default On

3.7.9 Limiter Mode

This configures the settings for performing each On Power and Off Power measurement with measurement path switched. This function is available on the MS2690A/MS2691A/MS2692A, and is not available on the MS2830A.

Procedure

 >  (Power vs Time) >  (Limiter Mode)

Limiter Mode

This sets whether or not to switch the measurement path in each On Power and Off Power measurement.

Procedure

 >  (Power vs Time) >  (Limiter Mode)
>  (Limiter Mode)

Options Off, On

Default Off

This can be set only when Wide Dynamic Range is On and Trigger Switch is On. If the measurement function is changed from Power vs Time to the other one, Limiter Mode is switched to Off.





 3.3.1 Trigger Switch

 3.7.1 Wide Dynamic Range

Limiter Mode ATT

This sets the attenuator for noise level and Off Power measurements.

Procedure

 >  (Power vs Time) >  (Limiter Mode)
>  (Limiter Mode ATT)

Range 0 to 60 dB

Default 2 dB

Resolution 2 dB

Limiter Mode ATT can be set only when Limiter Mode is set to On.

Note:

When Limiter Mode is On, the attenuator set by Limiter Mode ATT is set to noise level measurement and Off Power measurement, regardless of Input Level. The signal to input to the MS2690A/MS2691A/MS2692A must be lower than its maximum input level. Especially when Pre-AMP Mode is set to On, pay attention to the maximum input level of MS2690A/MS2691A/MS2692A because Pre-Amp is turned on accordingly.

Limiter Mode Offset

This sets whether or not to add the offset when displaying the Off Power measurement result.

Procedure

Measure > F2 (Power vs Time) > F8 (Limiter Mode)
> F3 (Limiter Mode Offset)

Options Off, On

Default Off

Limiter Mode Offset can be set only when Limiter Mode is set to On.

Limiter Mode Offset Value

This sets the offset to be added when displaying the Off Power measurement result. The offset value is an increase or decrease that occurs in the input signal level when the signal passes through cables, attenuators and amplifiers in a measurement path.

Procedure

Measure > F2 (Power vs Time) > F8 (Limiter Mode)
> F2 (Limiter Mode Offset Value)

Range -99.99 to 99.99 dB

Default 0.00 dB

Resolution 0.01 dB

Limiter Mode Offset Value can be set only when Limiter Mode Offset is set to On.

Noise Correction Mode

This sets the timing to perform noise level measurement.

Procedure

Measure > F2 (Power vs Time) > F8 (Limiter Mode)
> F6 (Noise Correction Mode)

Options Auto, Manual

Auto Performs noise level measurement for Noise Correction every time Power vs Time is performed.

Manual Performs noise level measurement for Noise Correction only when F7 (Noise Calculate) is pressed.





Default Auto

Noise Correction Mode can be set only when Noise Correction is set to On and Limiter Mode is set to On.



Noise Calculate

This executes the noise level measurement.

Procedure

 >  (Power vs Time) >  (Limiter Mode)
>  (Noise Calculate)

Noise Calculate can be set only when Noise Correction Mode is set to Manual.

Noise level measurement is performed by pressing  (Noise Calculate). The measured noise level is stored in the memory area for the MX269022A and is used by the Off Power measurement if Noise Correction is set to On. The measured noise level is initialized by turning off the power of the MS2690A/MS2691A/MS2692A or quitting the MX269022A, but is not initialized by pressing  or switching the measurement function.

3.8 Measurement and Result for Power vs Time

Power vs Time measurement is performed in accordance with the Uplink-downlink Configuration setting targeting 1 frame section.

Power vs Time measurement is performed as described below.

Procedure

1. Set frequency, level and trigger.

 [3.2 Setting Frequency and Level](#)

 [3.3 Setting Trigger](#)

2. Set the system parameters.

 [3.4 Shared Settings](#)

3. Press  >  (Power vs Time).

4. Set the parameters related with the Power vs Time measurement.

 [3.7 Power vs Time Setting](#)

5. Set the parameters for averaging.

 [3.8.1 Averaging \(Storage\)](#)

6. Perform the measurement.

 [3.1.3 Performing Measurement](#)

7. Select the displayed details.

 [3.8.3 Marker](#)

If Limiter Mode is On, Power vs Time measurement is performed in the following sequence.

1. Noise Level Measurement

This is performed when Noise Correction is set to On. Note that if Noise Correction Mode is set to Manual, this measurement is not performed upon start of Power vs Time measurement but is performed only when **F7** (Noise Calculate) is pressed.

 3.7.8 Limiter Mode

2. Off Power Measurement

3. On Power Measurement

Before proceeding with each of these measurement items, Power vs Time measurement pauses and prompts you to press **F1** (Continue) to continue. Measurement results are displayed when On Power measurement is completed.



Figure 3.8-1 Continue Screen

3.8.1 Averaging (Storage)

Storage Mode

This sets whether to set averaging.

Procedure

 >  (Storage) >  (Mode)



Options Off Disables averaging
 Average Enables averaging

Default Off

Storage Count

This sets the averaging count.

Procedure

 >  (Storage) >  (Count)

Range 2 to 999

Default 10

Resolution 1

3.8.2 Main Numeric Results

The main numeric results of Power vs Time measurement are listed below:

- (1) Off Power [dBm]
Displays average power for Off section specified by Mask line in dBm units
- (2) Off Power [dBm/MHz]
Displays average power for Off section specified by Mask line in dBm/MHz units
- (3) Off Power [dBm/MHz] – judgment
Displays Pass/Fail evaluation by comparison with Off Power Limit [dBm/MHz] setting
- (4) On Power [dBm]
Displays average power on dBm of on Power section specified by Uplink-downlink Configuration and Special Subframe Configuration
- (5) Transient Period [μ s]
Displays signal rise/fall time for On/Off boundary specified by Uplink-downlink Configuration and Special Subframe Configuration settings
At rising signal, displays time to On/Off boundary after signal becomes higher than Off Power Limit setting
At falling signal, displays time until signal power falls from On/Off boundary to below Off Power Limit setting
- (6) Transient Period [μ s] – judgment
Evaluates whether or not each Transient Period value is within selected Mask setting time range
- (7) Power at Mask Edge [dBm]
Displays signal power (dBm) at Start and Stop times of each Mask
- (8) Power at Mask Edge [dBm] - judgement
Evaluates whether or not Power at Mask Edge value is within Off Power Limit setting range
- (9) Mask Judge – Total
Evaluates whether or not signal in Gap1 and Gap2 sections within set level range for selected Mask
- (10) Mask Judge – Gap1
Evaluates whether or not signal in Gap1 section within set level range for selected Mask

(11) Mask Judge – Gap2

Evaluates whether or not signal in Gap2 section within set level range for selected Mask

(12) Top Graph

Displays time variation of signal in 1 Frame section

(13) Bottom Graph

Displays time variation of signal in following range centered on time period selected by Top Graph Marker

Range: $Sts - 1536$ to $Sts + 1535 Ts$

Sts is the header position (Ts) of the Symbol selected by TopGraphMarker.

3.8.3 Marker

The marker is displayed in the graph on the screen.

Procedure



Or



The procedures using is described below.

Marker

This sets the marker on/off.

Procedure



Options On, Off

Default On

Graph Select

This selects the marker specified graph. The graph marker to be set here can be set only.

Procedure



Or



Options Top Graph Select, Bottom Graph Select

Default Top Graph Select

Top Graph Marker Number

This sets the marker position displayed on the Top Graph.

Procedure

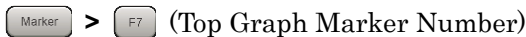

Range 0 to 139.75 symbol

Default 0

Bottom Graph Marker Number

This sets the marker position displayed on the Bottom Graph.

Procedure

 >  (Bottom Graph Marker Number)

Range Sts-1536 to Sts +1535 Ts

Default 0

Sts is the header position (Ts) of the Symbol selected by TopGraphMarker.

Top Graph Marker to Transient

This moves the marker displayed at Top Graph to the signal transient (on/Off boundary) determined by the Uplink-downlink Configuration, and Special Subframe Configuration settings.



Procedure

 >  (Top Graph Marker to Transient)

Top Graph Marker to Fail

This moves the marker displayed at Top Graph to the fail part.

Procedure



 >  (Top Graph Marker to Fail)

Peak Search (Margin)



This moves the marker to the peak point of the Margin result calculated using the measurements and Mask setting for the Off section specified at Mask Setup. If there are several peak points, the marker moves to the smallest point on the Time axis.

Margin = Measured value (dBm/MHz) – Mask setting (dBm/MHz)

Procedure

 >  >  (Peak Search (Margin))

Or

 >  (Peak Search (Margin))

Next Peak

This moves the marker to the point with the next largest margin relative to Margin of the current marker point in the measurement range.

Procedure

 >  >  (Next Peak)

Or

 >  (Next Peak)

3.9 MIMO Summary Settings

At MIMO Summary measurements for Tx Diversity and MIMO signals, the mixed signal from multiple antennas is input and the time difference between each antenna is measured.

For parameters that are not explained in this section, refer to the explanations of parameters with the same name in the modulation analysis measurement section.





 3.4 Common Settings

 3.5 Setting Modulation Analysis



3.9.1 Number of Antenna Ports

This sets the number of antennas for the DUT. RS analysis is performed for each antenna port of the set number of antennas.

Procedure

 ^{Menu} >  (Common Setting) >  (Reference Signal)
>  (Number of Antenna Ports)

Or

 >  (Modulation Analysis) >  (Detail Settings)





Options 1, 2, 4

Default 1



3.9.2 Antenna Port

This sets the antenna number for the input signal used as the reference for the measurement results.

Procedure

 ^{Menu} >  (Common Setting) >  (Reference Signal)
>  (Antenna Port)

Or

 >  (Modulation Analysis) >  (Detail Settings)

Options 0 to (Number of Antenna Ports – 1)

Default 0

 3.4.9 Number of Antenna Ports

3.9.3 Active Antenna Threshold

This sets the threshold value for On/Off evaluation of the Antenna Port signal. The RS power of the set Antenna Port signal is used as the reference to evaluate the RS power of the signal of each Antenna Port.

Procedure

 >  (MIMO Summary) >  (Active Antenna Threshold)

Range -100.0 to 0.0

Default -100.0

3.10 MIMO Summary Measurement Results

At MIMO Summary measurement, the timing, etc., between each antenna is measured by inputting signals from each antenna simultaneously and analyzing the RS of each signal.

MIMO Summary measurement is performed as described below:

Procedure

1. Set frequency, level and trigger.

 3.2 Setting Frequency and Level

 3.3 Setting Trigger

2. Set system parameters.

 3.4 Common Settings

3. Set the parameters for averaging.

 3.6.1 Setting Storage Mode/Count

4. Perform the measurement.

 3.1.3 Performing Measurement

3.10.1 Numeric Results

The main numeric results for MIMO Summary are as follows:

(1) RS Power

The difference in the RS Power between the antenna signal specified at Antenna Port and the signal for each antenna specified at Number of Antenna Ports is displayed in dB units.

(2) RS EVM

This displays each RS EVM value for the number of antennas specified at Number of Antenna Ports.

(3) RS Timing Offset

This displays the RS time difference between the antenna signal specified at Antenna Port and each of the number of antennas specified at Number of Antenna Ports.

(4) RS Freq

This displays the frequency difference between the antenna signal specified at Antenna Port and each of the number of antennas specified at Number of Antenna Ports.

(5) RS Phase

This displays the phase difference between the antenna signal specified at Antenna Port and each of the number of antennas specified at Number of Antenna Ports.

3.11 Setting Batch Measurement

This section explains the measurement conditions for batch measurement.

3.11.1 Common Settings : Storage Mode

This sets the storage mode of Modulation Analysis.

Procedure

Measure > → > F1 (Batch Measurement) > F1 (Batch Settings)
> F1 (Common Settings)

Options Off, Average, Average&Max
Default Off

3.11.2 Common Settings : Storage Count

This sets the measurement count of Modulation Analysis.

Procedure

Measure > → > F1 (Batch Measurement) > F1 (Batch Settings)
> F1 (Common Settings)

Range 2 to 9999
Default 10

3.11.3 Common Settings : Storage Mode for Unwanted Emissions

This sets the storage mode of Modulation Analysis for Unwanted Emissions.

Procedure





Measure > → > F1 (Batch Measurement) > F1 (Batch Settings)
> F1 (Common Settings)

Options Off, Average
Default Off

3.11.4 Common Settings : Storage Count for Unwanted Emissions

This sets the measurement count of Modulation Analysis for Unwanted Emissions.

Procedure

 >  >  (Batch Measurement) >  (Batch Settings)
 >  (Common Settings)





Range 2 to 9999

Default 10

3.11.5 Common Settings : Starting Subframe Number

This sets the analysis starting position.

Procedure

 >  >  (Batch Measurement) >  (Batch Settings)
 >  (Common Settings)

Range Refer to Table 3.11.5-1

Table 3.11.5-1 Common Settings : Starting Subframe Number setting Range

Uplink-downlink Configuration	Range
0	0, 5 + 10 × N
1	0, 4, 5, 9 + 10 × N
2	0, 3, 4, 5, 8, 9 + 10 × N
3	0, 5, 6, 7, 8, 9 + 10 × N
4	0, 4, 5, 6, 7, 8, 9 + 10 × N
5	0, 3, 4, 5, 6, 7, 8, 9 + 10 × N
6	0, 5, 9 + 10 × N

CC Settings : When Test Model Starting Frame Type is Unlock.

N = 0 to 4

CC Settings : When Test Model Starting Frame Type is Frame1 or Frame2.

N = 0 to 3

The values usable for all CC items to measure can be set.

Default 0

 3.5.1 Starting Subframe Number

3.11.6 Common Settings : Measurement Interval

This sets the analysis interval in subframe units. The value is set as the interval of contiguous subframes, irrespective of the subframe type.

The subframes for modulation analysis are the Downlink subframe and the Special subframe. The measurement results are unaffected even if the Uplink subframe count including the start to finish measurement interval is changed.

Procedure

Measure > → > F1 (Batch Measurement) > F1 (Batch Settings)
> F1 (Common Settings)

Range	When CC Settings : Test Model Starting Frame Type is Unlock. 1 to (50 – Common Settings : Starting Subframe Number) Subframes When CC Settings : Test Model Starting Frame Type is Frame1 or Frame2. 1 to (40 – Common Settings : Starting Subframe Number) Subframes
Default	10

 3.5.2 Measurement Interval

3.11.7 Common Settings : Starting OFDM Symbol Number

This sets the analysis starting position of Unwanted Emissions.

Procedure

Measure > → > F1 (Batch Measurement) > F1 (Batch Settings)
> F1 (Common Settings)

Range	(0 to 13) + 14 × (Common Settings : Range of Starting Subframe Number) OFDM Symbol
Default	3

3.11.8 Common Settings : Measurement Interval for Unwanted Emissions

This sets the analysis interval for Unwanted Emissions in OFDM Symbol units. The value is set as the interval of contiguous OFDM Symbols, irrespective of the subframe type.

The subframes for modulation analysis are the Downlink subframe and the Special subframe. The measurement results are unaffected even if the Uplink subframe count including the start to finish measurement interval is changed.

Procedure

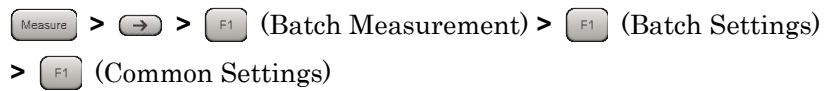

Range	When CC Settings : Test Model Starting Frame Type is Unlock. 1 to (700 – Common Settings : Starting OFDM Symbol Number) OFDM Symbol When CC Settings : Test Model Starting Frame Type is Frame1 or Frame2. 1 to (560 – Common Settings : Starting OFDM Symbol Number) OFDM Symbol
Default	1

3.11.9 Common Settings : Modulation Analysis

This enables/disables Modulation Analysis.

Procedure

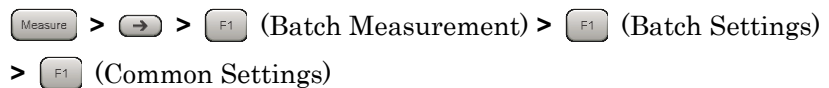

Options	Off, On
Default	On

3.11.10 Common Settings : OBW

This enables/disables OBW measurement. The measurement is not executed if the required frequency bandwidth exceeds the analysis bandwidth.

Procedure

Measure > → > F1 (Batch Measurement) > F1 (Batch Settings)
> F1 (Common Settings)

Options Off, On

Default On

3.11.11 Common Settings : ACLR

This enables/disables ACLR measurement. The measurement is not executed if the required frequency bandwidth exceeds the analysis bandwidth.

Procedure

Measure > → > F1 (Batch Measurement) > F1 (Batch Settings)
> F1 (Common Settings)

Options Off, On

Default On

3.11.12 Common Settings : OBUE (Operating Band Unwanted Emissions)

This enables/disables OBUE measurement. The measurement is not executed if the required frequency bandwidth exceeds the analysis bandwidth.

Procedure

Measure > → > F1 (Batch Measurement) > F1 (Batch Settings)
> F1 (Common Settings)

Options Off, On

Default On

3.11.13 Band Settings : Measurement Item

This sets the measurement items for every Band.

Procedure

Measure > → > F1 (Batch Measurement) > F1 (Batch Settings)
> F2 (Band Settings)

Options

Band #0	Measures the Band 0.
Band #1	Measures the Band 1.
Band #2	Measures the Band 2.

Default

Band #0	On
Band #1	Off
Band #2	Off

Notes:

- When the MX269022A-001 is not installed, it is fixed to Band 0.
- When MS2830A -078 is installed, this is fixed to Band 0.

3.11.14 Band Settings : Carrier Frequency

This sets a carrier frequency.

Procedure

Measure > → > F1 (Batch Measurement) > F1 (Batch Settings)
> F2 (Band Settings)

Range

100 MHz to the upper limit of the main unit
(When MS269xA-004/104/078/178, MS2830A-078 is not installed)
100 MHz to the upper limit of the main unit
(When MS269xA-004/104/078/178 is installed)
300 MHz to the upper limit of the main unit
(When MS2830A-078 is installed)

Default

Band #0	2140MHz
Band #1	1960MHz
Band #2	1842.5MHz

3.11.15 Band Settings : Input Level

This sets the input level from the target DUT.

Procedure

Measure > → > F1 (Batch Measurement) > F1 (Batch Settings)
> F2 (Band Settings)

Range

For Pre-Amp: On
(-80.00 + Offset Value) to (10.00 + Offset Value) dBm
For Pre-Amp: Off
(-60.00 + Offset Value) to (30.00 + Offset Value) dBm

Default

Band #0,1,2	-10.00dBm
-------------	-----------

3.11.16 Band Settings : Pre-Amp

This sets On/Off for the Pre-Amp function.

Procedure

Measure > → > F1 (Batch Measurement) > F1 (Batch Settings)
> F2 (Band Settings)

Options

On Enables the Pre-Amp function.
Off Disables the Pre-Amp function.

Default

Band #0,1,2 Off

3.11.17 Band Settings : Level Offset

This sets On/Off for the offset function.

Procedure

Measure > → > F1 (Batch Measurement) > F1 (Batch Settings)
> F2 (Band Settings)

Options

On Enables the offset function.
Off Disables the offset function.

Default

Band #0,1,2 Off

3.11.18 Band Settings : Offset Value

This sets the level offset coefficient.

Procedure

Measure > → > F1 (Batch Measurement) > F1 (Batch Settings)
> F2 (Band Settings)

Range

-99.99 to 99.99 dB

Default

Band #0,1,2 00.00dB

3.11.19 Band Settings : Contiguous Mode

This sets On/Off for the contiguous mode.

Procedure

Measure > → > F1 (Batch Measurement) > F1 (Batch Settings)
> F2 (Band Settings)

Options

On Enables the Contiguous Mode.
Off Disables the Contiguous Mode.

Default

Band #0,1,2 Off

Note:

When the MX269022A-001, and MS269xA-004/104/078/178 or MS2830A-078 is not installed, it is fixed to Off.

3.11.20 Band Settings : OBUE Standard

This sets the standard template for OBUE measurement.

Procedure

Measure > → > F1 (Batch Measurement) > F1 (Batch Settings)
> F2 (Band Settings)

Options

WideBS Cat.A<1G	Wide Area BS Category A <1G
WideBS Cat.A 1-3G	Wide Area BS Category A 1-3G
WideBS Cat.A >3G	Wide Area BS Category A >3G
WideBS Cat.B Opt.1 <1G	Wide Area BS Category B Option 1 <1G
WideBS Cat.B Opt.1 1-3G	Wide Area BS Category B Option 1 1-3G
WideBS Cat.B Opt.1 >3G	Wide Area BS Category B Option 1 >3G
WideBS Cat.B Opt.2	Wide Area BS Category B Option 2
LocalBS Cat.A&B ≤3G	Local Area BS Category A&B ≤3G
LocalBS Cat.A&B >3G	Local Area BS Category A&B >3G
HomeBS Cat.A&B ≤3G	Home BS Category A&B ≤3G
HomeBS Cat.A&B >3G	Home BS Category A&B >3G

Default

Band #0,1,2 WideBS Cat.A <1G

3.11.21 Band Settings : OBUE Standard Additional

This sets the additional standard template for OBUE measurement.

Procedure

Measure > → > F1 (Batch Measurement) > F1 (Batch Settings)
> F2 (Band Settings)

Options

Off Not use the additional standard template
Band 2,4,10,23,25,35,36,41 Band2,4,10,23,25,35,36,41

Default

Band #0,1,2 OFF

3.11.22 CC Settings : Measurement Item

This sets the measurement items for every CC.

Procedure

Measure > → > F1 (Batch Measurement) > F1 (Batch Settings)
> F3 (CC Settings)

Options

CC #0 Measures the CC 0.
CC #1 Measures the CC 1.
CC #2 Measures the CC 2.
CC #3 Measures the CC 3.
CC #4 Measures the CC 4.

Default

When the MX269022A-001 is installed, and the
MS269xA-004/104/078/178 or MS2830A-078 is installed

CC #0 On
CC #1,2,3,4 Off

When the MX269022A-001 is installed, but the
MS269xA-004/104/078/178 or MS2830A-078 is not installed

CC #0,1,2 On fixed
CC #3,4 Off fixed

When the MX269022A-001 is not installed,

CC #0 On fixed
CC #1,2,3,4 Off fixed

3.11.23 CC Settings : Frequency Band

This sets the frequency band for every CC.

Procedure

Measure > → > F1 (Batch Measurement) > F1 (Batch Settings)
> F3 (CC Settings)

Options

Band #0	Measures as the CC of Band 0.
Band #1	Measures as the CC of Band 1.
Band #2	Measures as the CC of Band 2.

Default

CC #0,1,2,3,4	Band #0
---------------	---------

Notes:

- When the MX269022A-001 is not installed, it is fixed to Band 0.
- When MS2830A-078 are installed to the mainframe, this is fixed to Band 0.

3.11.24 CC Settings : Frequency Offset

This sets the frequency offset for every CC.

Procedure

Measure > → > F1 (Batch Measurement) > F1 (Batch Settings)
> F3 (CC Settings)

Range

When MS269xA-004/104/078/178 or MS2830A-078 is installed.

–50000000 + (CC Settings : Channel Bandwidth/2)

to 50000000 – (CC Settings : Channel Bandwidth/2) Hz

When MS269xA-004/104/078/178 or MS2830A-078 is not installed.

–15625000 + (CC Settings : Channel Bandwidth/2)

to 15625000 – (CC Settings : Channel Bandwidth/2) Hz

Notes:

- When the MX269022A-001 is not installed, it is fixed to 0 Hz.
- The resolution is 300 kHz when Band Settings: Contiguous Mode is set to On.
- The resolution is 1 kHz when Band Settings: Contiguous Mode is set to Off.

Default

CC #0,1,2,3,4	0 Hz
---------------	------

3.11.25 CC Settings : Channel Bandwidth

Selects a band of an input signal for every CC.

Procedure

Measure > → > F1 (Batch Measurement) > F1 (Batch Settings)
> F3 (CC Settings)

Options

- 1.4 MHz Analyzes an input signal as a 1.4-MHz band.
- 3 MHz Analyzes an input signal as a 3-MHz band.
- 5 MHz Analyzes an input signal as a 5-MHz band.
- 10 MHz Analyzes an input signal as a 10-MHz band.
- 15 MHz Analyzes an input signal as a 15-MHz band.
- 20 MHz Analyzes an input signal as a 20-MHz band

Default

CC #0,1,2,3,4 5 MHz

3.11.26 CC Settings : Test Model

Selects the type of the test model defined in 3GPP TS36.141.

Procedure

Measure > → > F1 (Batch Measurement) > F1 (Batch Settings)
> F3 (CC Settings)

Options

- Off Select when measuring signals other than the test model.
- E-TM1.1 Select when measuring E-TM1.1 signals.
- E-TM1.2 Select when measuring E-TM1.2 signals.
- E-TM2 Select when measuring E-TM2 signals.
- E-TM2a Select when measuring E-TM2a signals.
- E-TM3.1 Select when measuring E-TM3.1 signals.
- E-TM3.1a Select when measuring E-TM3.1a signals.
- E-TM3.2 Select when measuring E-TM3.2 signals.
- E-TM3.3 Select when measuring E-TM3.3 signals.

Default

CC #0,1,2,3,4 Off

3.11.27 CC Settings : Test Model Starting Frame Type

When the input signal is an E-UTRA Test Model (Test Model hereafter) defined by 3GPP TS36.141, Test Model is set. The Test Model signal E-TM1.2, 2, 2a, 3.2, and 3.3 are composed of frame1 and frame2. This function sets either frame 1 or frame 2 as the header frame for starting analysis. Select Unlock when specifying nothing.

This is enabled when CC Settings: Test Model is E-TM1.2, E-TM2, E-TM2a, E-TM3.2 or E-TM3.3.

Procedure

Measure > → > F1 (Batch Measurement) > F1 (Batch Settings)
> F3 (CC Settings)

Options

UnLock No specified target
Frame1 Specifies frame1
Frame2 Specifies frame2

Default

CC #0,1,2,3,4 UnLock

3.11.28 CC Settings : Uplink-downlink Configuration

This sets the position of the Downlink subframe in the frame for every CC.

This is enabled when CC Settings: Test Model is Off. This parameter is fixed 3 when CC Settings: Test Model is not Off.

Procedure

Measure > → > F1 (Batch Measurement) > F1 (Batch Settings)
> F3 (CC Settings)

Range

0 to 6

Default

CC #0,1,2,3,4 3

3.11.29 CC Settings : Special Subframe Configuration

This sets the configuration of the special subframe for each CC.

This is enabled when CC Settings: Test Model is Off. This parameter is fixed 8 when CC Settings: Test Model is not Off.

Procedure

Measure > → > F1 (Batch Measurement) > F1 (Batch Settings)
> F3 (CC Settings)

Range

0 to 8

Default

CC #0,1,2,3,4 8

3.11.30 CC Settings : Synchronization Mode

This sets the type of physical signal used for synchronization processing with the input signal for every CC. When Reference Signal is selected, Cell ID must also be set correctly.

This is enabled when CC Settings: Test Model is Off. This parameter is fixed Synchronization Signal when CC Settings: Test Model is not Off.

Procedure

Measure > → > F1 (Batch Measurement) > F1 (Batch Settings)
> F3 (CC Settings)

Options

SS Sets Synchronization Signal for the synchronized signal.
RS Sets Reference Signal for the synchronized signal.

Default

CC #0,1,2,3,4 SS

3.11.31 CC Settings : Cell ID

This sets the Cell ID for every CC

This is enabled when CC Settings : Synchronization Mode is Reference Signal.

Procedure

Measure > → > F1 (Batch Measurement) > F1 (Batch Settings)
> F3 (CC Settings)

Range

0 to 503

Default

CC #0,1,2,3,4 0

3.11.32 CC Settings : CRS Power Boosting

This sets the boost level of the CRS for every CC.

This is enabled when CC Settings: Test Model is Off. This parameter is fixed 0.000 dB when CC Settings: Test Model is not Off.

Procedure

Measure > → > F1 (Batch Measurement) > F1 (Batch Settings)
> F3 (CC Settings)

Range

-20.000 to +20.000 dB

Default

CC #0,1,2,3,4 0.000 dB

3.11.33 CC Settings : CRS Number of Antenna Ports

This sets the number of antennas for the CRS for every CC.

This is enabled when CC Settings: Test Model is Off. This parameter is fixed 1 when CC Settings: Test Model is not Off.

Procedure

Measure > → > F1 (Batch Measurement) > F1 (Batch Settings)
> F3 (CC Settings)

Options

- 1 Analyzes under the condition that the number of antennas used for transmission is 1.
- 2 Analyzes under the condition that the number of antennas used for transmission is 2.
- 4 Analyzes under the condition that the number of antennas used for transmission is 4.

Default

CC #0,1,2,3,4 1

3.11.34 CC Settings : CSI-RS Number of Antenna Ports

This sets the number of antennas for the CSI-RS for every CC.

This is enabled when the MX269022A-001 is installed and CC Settings: CSI-RS On/Off is On. This parameter is fixed 1 when CC Settings: Test Model is not Off.

Procedure

Measure > → > F1 (Batch Measurement) > F1 (Batch Settings)
> F3 (CC Settings)

Options

- 1 Analyzes under the condition that the number of antennas used for transmission is 1.
- 2 Analyzes under the condition that the number of antennas used for transmission is 2.
- 4 Analyzes under the condition that the number of antennas used for transmission is 4.
- 8 Analyzes under the condition that the number of antennas used for transmission is 8.

Default

CC #0,1,2,3,4 1

3.11.35 CC Settings : CRS Antenna Port

This sets the CRS antenna port number for every CC.

This is enabled when CC Settings: Test Model is Off. This parameter is fixed 0 when CC Settings: Test Model is not Off.

Procedure

Measure > → > F1 (Batch Measurement) > F1 (Batch Settings)
> F3 (CC Settings)

Range

0 to (CC CRS Number of Antenna Ports – 1)

Default

CC #0,1,2,3,4 0

3.11.36 CC Settings : CSI-RS Antenna Port

This sets the CSI-RS antenna port number for every CC

This is enabled when the MX269022A-001 is installed and CC Settings: CSI-RS On/Off is On. This parameter is fixed 15 when CC Settings: Test Model is not Off.

Procedure

Measure > → > F1 (Batch Measurement) > F1 (Batch Settings)
> F3 (CC Settings)

Range

15 to (CC CSI-RS Number of Antenna Ports + 14)

Default

CC #0,1,2,3,4 15

3.11.37 CC Settings : PDSCH Modulation Scheme

This sets PDSCH Modulation Scheme.

This is enabled when CC Settings: Test Model is Off.

Procedure

Measure > → > F1 (Batch Measurement) > F1 (Batch Settings)
> F3 (CC Settings)

Options

- QPSK Analyzes an input signal as a QPSK modulated signal.
- 16QAM Analyzes an input signal as a 16QAM modulated signal.
- 64QAM Analyzes an input signal as a 64QAM modulated signal.
- 256QAM Analyzes an input signal as a 256QAM modulated signal.
- AUTO Analyzes an input signal after judging its modulation scheme automatically (Excluding 256QAM).

Default

CC #0,1,2,3,4 AUTO

3.11.38 CC Settings : EVM Window Length

This sets the length of EVM Window applied to OFDM symbol as the width from the center position of Cyclic prefix. It can be set either as the FFT sample count W, or in Ts units (time per sample).

Procedure

Measure > → > F1 (Batch Measurement) > F1 (Batch Settings)
> F3 (CC Settings)

Range

Ts : 0 to 142

W : When CC Settings: Channel Bandwidth is 1.4 MHz: 0 to 8

When CC Settings: Channel Bandwidth is 3 MHz: 0 to 17

When CC Settings: Channel Bandwidth is 5 MHz: 0 to 35

When CC Settings: Channel Bandwidth is 10 MHz: 0 to 71

When CC Settings: Channel Bandwidth is 15 MHz: 0 to 106

When CC Settings: Channel Bandwidth is 20 MHz: 0 to 142

Default

CC #0,1,2,3,4

When CC Settings: Channel Bandwidth is 1.4 MHz: 5W, 80Ts

When CC Settings: Channel Bandwidth is 3 MHz: 12W, 96Ts

When CC Settings: Channel Bandwidth is 5 MHz: 32W, 128Ts

When CC Settings: Channel Bandwidth is 10 MHz: 66W, 132Ts

When CC Settings: Channel Bandwidth is 15 MHz: 102W, 136Ts

When CC Settings: Channel Bandwidth is 20 MHz: 136W, 136Ts

3.11.39 CC Settings : Channel Estimation

This sets the Channel Estimation function for the CC to On/Off.

When CC Settings : Channel Estimation is On, amplitude and phase estimation is performed based on the Reference Signal.

Procedure

Measure > → > F1 (Batch Measurement) > F1 (Batch Settings)
> F3 (CC Settings)

Options

On Enables the Channel Estimation function.
Off Disables the Channel Estimation function.

Default

CC #0,1,2,3,4 On

3.11.40 CC Settings : DwPTS

This sets whether or not to measure DwPTS for every CC.

Procedure

Measure > → > F1 (Batch Measurement) > F1 (Batch Settings)
> F3 (CC Settings)

Options

Include Target measurement includes DwPTS.
Exclude Target measurement does not include DwPTS.

Default

CC #0,1,2,3,4 Exclude

3.11.41 CC Settings : DwPTS for Unwanted Emissions

This sets whether to include/exclude CC DwPTS for Unwanted Emissions.

Procedure

Measure > → > F1 (Batch Measurement) > F1 (Batch Settings)
> F3 (CC Settings)

Options

Include DwPTS for Unwanted Emissions is included.
Exclude DwPTS for Unwanted Emissions is excluded.

Default

CC #0,1,2,3,4 Include

3.11.42 CC Settings : Measurement Filter Type

This sets the filter type used for modulation analysis for every CC.

This is enable when Band Settings : Contiguous Mode is Off.

Procedure

Measure > → > F1 (Batch Measurement) > F1 (Batch Settings)
> F3 (CC Settings)

Options

Normal For measuring single carrier signal.

Narrow For measuring multi-carrier signal.

Default

CC #0,1,2,3,4 Normal

3.11.43 CC Settings : PBCH On/Off

This enables or disables the PBCH for every CC.

This is enabled when CC Settings: Test Model is Off. This parameter is fixed On when CC Settings: Test Model is not Off.

Procedure

Measure > → > F1 (Batch Measurement) > F1 (Batch Settings)
> F3 (CC Settings)

Options

On Target measurement includes PBCH.

Off Target measurement does not include PBCH.

Default

CC #0,1,2,3,4 On

3.11.44 CC Settings : PBCH Power Auto/Manual

This sets the method for determining the PBCH Boost level for every CC.

This is enabled when CC Settings: Test Model is set to Off and CC Settings: PBCH On/Off is set to On.

Procedure

Measure > → > F1 (Batch Measurement) > F1 (Batch Settings)
> F3 (CC Settings)

Options

Auto Automatic detection
Manual Manual detection

Default

CC #0,1,2,3,4 Auto

3.11.45 CC Settings : PBCH Power Boosting

This sets the PBCH Boost level for every CC as a relative value based on the Reference Signal level.

This is enabled when CC Settings: Test Model is OFF, CC Settings: PBCH On/Off is On and CC Settings: PBCH Power Auto/Manual is Manual.

Procedure

Measure > → > F1 (Batch Measurement) > F1 (Batch Settings)
> F3 (CC Settings)

Range

-20.000 to +20.000 dB

Default

CC #0,1,2,3,4 0.000 dB

3.11.46 CC Settings : P-SS On/Off

This enables/disables P-SS (Primary Synchronization Signal) for every CC.

This is enabled when CC Settings : Synchronization Mode is Reference Signal. This parameter is fixed On when CC Settings : Synchronization Mode is Synchronization Signal.

Procedure

Measure > → > F1 (Batch Measurement) > F1 (Batch Settings)
> F3 (CC Settings)

Options

On The measurement target includes P-SS.
Off The measurement target does not include P-SS.

Default

CC #0,1,2,3,4 On

3.11.47 CC Settings : P-SS Power Auto/Manual

This sets the method for determining the P-SS Boost level for every CC.

This is enabled when CC Settings: Test Model is set to Off and CC Settings: P-SS On/Off is set to On.

Procedure

Measure > → > F1 (Batch Measurement) > F1 (Batch Settings)
> F3 (CC Settings)

Options

Auto Automatic detection
Manual Manual detection

Default

CC #0,1,2,3,4 Auto

3.11.48 CC Settings : P-SS Power Boosting

This sets the P-SS Boost level for every CC as a relative value based on the Reference Signal level.

This is enabled when CC Settings: Test Model is OFF, CC Settings: P-SS On/Off is On and CC Settings: P-SS Power Auto/Manual is Manual.

Procedure

Measure > → > F1 (Batch Measurement) > F1 (Batch Settings)
> F3 (CC Settings)

Range

-20.000 to +20.000 dB

Default

CC #0,1,2,3,4 0.000 dB

3.11.49 CC Settings : S-SS On/Off

This enables/disables S-SS (Secondary Synchronization Signal) for every CC.

This is enabled when CC Settings: Synchronization Mode is Reference Signal. This parameter is fixed On when CC Settings: Synchronization Mode is Synchronization Signal.

Procedure

Measure > → > F1 (Batch Measurement) > F1 (Batch Settings)
> F3 (CC Settings)

Options

On The measurement target includes S-SS.
Off The measurement target does not include S-SS.

Default

CC #0,1,2,3,4 On

3.11.50 CC Settings : S-SS Power Auto/Manual

This sets the method for determining the S-SS Boost level for every CC.

This is enabled when CC Settings: Test Model is OFF and CC Settings: S-SS On/Off is On.

Procedure

Measure > → > F1 (Batch Measurement) > F1 (Batch Settings)
> F3 (CC Settings)

Options

Auto Automatic detection
Manual Manual detection

Default

CC #0,1,2,3,4 Auto

3.11.51 CC Settings : S-SS Power Boosting

This sets the S-SS Boost level for every CC as a relative value based on the Reference Signal level.

This is enabled when CC Settings: Test Model is Off, CC Settings: S-SS On/Off is On and CC Settings: S-SS Power Auto/Manual is Manual.

Procedure

Measure > → > F1 (Batch Measurement) > F1 (Batch Settings)
> F3 (CC Settings)

Range

-20.000 to +20.000 dB

Default

CC #0,1,2,3,4 0.000 dB

3.11.52 CC Settings : PDCCH On/Off

This enables or disables the PDCCH for every CC.

This is enabled when CC Settings: Test Model is Off. This parameter is fixed On when CC Settings: Test Model is not Off.

Procedure

Measure > → > F1 (Batch Measurement) > F1 (Batch Settings)
> F3 (CC Settings)

Options

On The measurement target includes PDCCH.

Off The measurement target does not include PDCCH.

Default

CC #0,1,2,3,4 On

3.11.53 CC Settings : PDCCH Power Auto/Manual

This sets the method for determining the PDCCH Boost level for every CC.

This is enabled when CC Settings: Test Model is Off and CC Settings: PDCCH On/Off is On.

Procedure

Measure > → > F1 (Batch Measurement) > F1 (Batch Settings)
> F3 (CC Settings)

Options

Auto Automatic detection

Manual Manual detection

Default

CC #0,1,2,3,4 Auto

3.11.54 CC Settings : PDCCH Power Boosting

This sets the PDCCH Boost level for every CC as a relative value based on the Reference Signal level.

This is enabled when CC Settings: Test Model is Off, CC Settings: PDCCH On/Off is On and CC Settings: PDCCH Power Auto/Manual is Manual.

Procedure

Measure > → > F1 (Batch Measurement) > F1 (Batch Settings)
> F3 (CC Settings)

Range

-20.000 to +20.000 dB

Default

CC #0,1,2,3,4 0.000dB

3.11.55 CC Settings : PCFICH On/Off

This enables or disables the PCFICH for every CC.

This is enabled when CC Settings: Test Model is Off. This parameter is fixed On when CC Settings: Test Model is not Off.

Procedure

Measure > → > F1 (Batch Measurement) > F1 (Batch Settings)
> F3 (CC Settings)

Options

On The measurement target includes PCFICH

Off The measurement target does not include PCFICH

Default

CC #0,1,2,3,4 On

3.11.56 CC Settings : PCFICH Power Auto/Manual

This sets the method for determining the PCFICH Boost level for every CC.

This is enabled when CC Settings: Test Model is Off and CC Settings: PCFICH On/Off is On.

Procedure

Measure > → > F1 (Batch Measurement) > F1 (Batch Settings)
> F3 (CC Settings)

Options

Auto Automatic detection

Manual Manual detection

Default

CC #0,1,2,3,4 Auto

3.11.57 CC Settings : PCFICH Power Boosting

This sets the PCFICH Boost level for every CC as a relative value based on the Reference Signal level.

This is enabled when CC Settings: Test Model is Off, CC Settings: PCFICH On/Off is On and CC Settings: PCFICH Power Auto/Manual is Manual.

Procedure

Measure > → > F1 (Batch Measurement) > F1 (Batch Settings)
> F3 (CC Settings)

Range

-20.000 to +20.000 dB

Default

CC #0,1,2,3,4 0.000dB

3.11.58 CC Settings : PHICH On/Off

This enables or disables the PHICH for every CC.

This is enabled when CC Settings: Test Model is Off. This parameter is fixed On when CC Settings: Test Model is not Off.

Procedure

Measure > → > F1 (Batch Measurement) > F1 (Batch Settings)
> F3 (CC Settings)

Options

On The measurement target includes PHICH
Off The measurement target does not include PHICH

Default

CC #0,1,2,3,4 On

3.11.59 CC Settings : PHICH Power Auto/Manual

This sets the method for determining the PHICH Boost level for every CC.

This is enable when CC Settings: Test Model is Off and CC Settings: PHICH On/Off is On.

Procedure

Measure > → > F1 (Batch Measurement) > F1 (Batch Settings)
> F3 (CC Settings)

Options

Auto Automatic detection
Manual Manual detection

Default

CC #0,1,2,3,4 Auto

3.11.60 CC Settings : PHICH Power Boosting

This sets the PHICH Boost level for every CC as relative value based on the Reference Signal level.

This is enabled when CC Settings: Test Model is Off, CC Settings: PHICH On/Off is On and CC Settings: PHICH Power Auto/Manual is Manual.

Procedure

Measure > → > F1 (Batch Measurement) > F1 (Batch Settings)
> F3 (CC Settings)

Range

-20.000 to +20.000 dB

Default

CC #0,1,2,3,4 0.000dB

3.11.61 CC Settings : PDSCH Power Auto/Manual

This sets the method for determining the PDSCH Boost level for every CC.

This is enabled when CC Settings: Test Model is Off and CC Settings: PDSCH Modulation Scheme is not AUTO.

Procedure

Measure > → > F1 (Batch Measurement) > F1 (Batch Settings)
> F3 (CC Settings)

Options

Auto Automatic detection

Manual Manual detection

Default

CC #0,1,2,3,4 Auto

3.11.62 CC Settings : PDSCH Power Boosting

This sets the PDSCH Boost level for every CC as a relative value based on the Reference Signal level.

This is enabled when CC Settings: Test Model is Off and CC Settings: PDSCH Power Auto/Manual is Manual.

Procedure

Measure > → > F1 (Batch Measurement) > F1 (Batch Settings)
> F3 (CC Settings)

Range

-20.000 to +20.000 dB

Default

CC #0,1,2,3,4 0.000dB

3.11.63 CC Settings : PHICH - Ng

This sets the Ng parameter for every CC, which is one parameter determining the PHICH group number.

This is enabled when CC Settings: Test Model is Off and CC Settings: PHICH On/Off is On.

Procedure

Measure > → > F1 (Batch Measurement) > F1 (Batch Settings)
> F3 (CC Settings)

Options

1/6 1/6 is set for Ng.

1/2 1/2 is set for Ng.

1 1 is set for Ng.

2 2 is set for Ng.

Default

CC #0,1,2,3,4 1/6

3.11.64 CC Settings : PHICH Duration

This sets the PHICH duration.

This is enabled when CC Settings: Test Model is Off and CC Settings: PHICH On/Off is On.

Procedure

Measure > → > F1 (Batch Measurement) > F1 (Batch Settings)
> F3 (CC Settings)

Options

Normal Normal
Extended Extended

Default

CC #0,1,2,3,4 Normal

3.11.65 CC Settings : Number of PDCCH Symbols - Auto/Manual

This selects automatic detection and manual setting of the number of OFDM symbols per PDCCH.

This is enabled when CC Settings: Test Model is Off, CC Settings: PDCCH On/Off is On and CC Settings: PCFICH On/Off is On.

Procedure

Measure > → > F1 (Batch Measurement) > F1 (Batch Settings)
> F3 (CC Settings)

Options

Auto Automatic detection
Manual Manual detection

Default

CC #0,1,2,3,4 Auto

3.11.66 CC Settings : Number of PDCCH Symbols for Subframe 1 and 6

This sets the Symbol number of PDCCH of subframe 1 and 6 for every CC.

This is enabled when CC Settings: Number of PDCCH Symbols - Auto/Manual is Manual and CC Settings: PDCCH On/Off is On.

Procedure

Measure > → > F1 (Batch Measurement) > F1 (Batch Settings)
> F3 (CC Settings)

Range

When CC Settings: Channel Bandwidth is set to 1.4 MHz: 2

When CC Settings: Channel Bandwidth is not 1.4 MHz: 1 to 2

Default

CC #0,1,2,3,4 1

3.11.67 CC Settings : Number of PDCCH Symbols

This sets the Symbol number of PDCCH except subframe 1 and 6 for every CC.

This is enabled when CC Settings: Number of PDCCH Symbols - Auto/Manual is Manual and CC Settings: PDCCH On/Off is On.

Procedure

Measure > → > F1 (Batch Measurement) > F1 (Batch Settings)
> F3 (CC Settings)

Range

When CC Settings: Channel Bandwidth is 1.4 MHz: 2 to 4

When CC Settings: Channel Bandwidth is not 1.4 MHz: 1 to 3

Default

CC #0,1,2,3,4 1

3.11.68 CC Settings : PDCCH Mapping

This sets mapping of PDCCH and NIL (dummy PDCCH) to the control channel elements (CCEs) for every CC.

This is enabled when CC Settings: Test Model is Off and CC Settings: PDCCH On/Off is On.

Procedure

Measure > → > F1 (Batch Measurement) > F1 (Batch Settings)
> F3 (CC Settings)

Options

Auto	Automatically evaluates and measures PDCCH and NIL
Easy	Performs measurement for all subframes according to the PDCCH mapping that is determined by the PDCCH Format and Number of PDCCHs parameters. Measurement is performed assuming that PDCCHs are mapped sequentially from the first CCE for the number specified by Number of PDCCHs in the unit specified by PDCCH Format.

Default

CC #0,1,2,3,4 Auto

3.11.69 CC Settings : PDCCH Format

This sets the PDCCH format for every CC.

This is enabled when CC Settings: Test Model is Off, CC Settings: PDCCH On/Off is On and CC Settings: PDCCH Mapping is Easy.

Procedure

Measure > → > F1 (Batch Measurement) > F1 (Batch Settings)
> F3 (CC Settings)

Range

0 to 3

Default

CC #0,1,2,3,4 0

3.11.70 CC Settings : Number of PDCCHs

This sets the PDCCH number included in 1 subframe for every CC.

This is enabled when CC Settings: Test Model is Off, CC Settings: PDCCH On/Off is On and CC Settings: PDCCH Mapping is Easy.

Procedure

Measure > → > F1 (Batch Measurement) > F1 (Batch Settings)
> F3 (CC Settings)

Range

1 to 88

Default

CC #0,1,2,3,4 1

3.11.71 CC Settings : CSI-RS On/Off

This enables or disables the PCFICH for every CC.

This is enabled when CC Settings: Test Model is Off. This parameter is fixed Off when CC Settings: Test Model is not Off. When the MX269022A-001 is not installed, it is fixed to Off.

Procedure

Measure > → > F1 (Batch Measurement) > F1 (Batch Settings)
> F3 (CC Settings)

Options

On The measurement target includes CSI-RS.

Off The measurement target does not include CSI-RS.

Default

CC #0,1,2,3,4 On

3.11.72 CC Settings : CSI-RS Configuration

This sets the CSI-RS Configuration for every CC.

This is enabled when the MX269022A-001 is installed and CC Settings: CSI-RS On/Off is On.

Procedure

Measure > → > F1 (Batch Measurement) > F1 (Batch Settings)
> F3 (CC Settings)

Range

When CSI-RS Number of Antenna Ports is 8 0 to 4, 20 to 22
When CSI-RS Number of Antenna Ports is 4 0 to 9, 20 to 25
When CSI-RS Number of Antenna Ports is 2 0 to 31
When CSI-RS Number of Antenna Ports is 1 0 to 31

Default

CC #0,1,2,3,4 0

3.11.73 CC Settings : CSI-RS Periodicity T

This sets CSI-RS Periodicity T for every CC.

This is enabled when the MX269022A-001 is installed and CC Settings: CSI-RS On/Off is On.

Procedure

Measure > → > F1 (Batch Measurement) > F1 (Batch Settings)
> F3 (CC Settings)

Options

5 Measures with CSI-RS Periodicity T set to 5.
10 Measures with CSI-RS Periodicity T set to 10.

Default

CC #0,1,2,3,4 5

3.11.74 CC Settings : CSI-RS Subframe Offset

This sets CSI-RS Subframe Offset for every CC.

This is enabled when the MX269022A-001 is installed and CC Settings: CSI-RS On/Off is On.

Procedure

Measure > → > F1 (Batch Measurement) > F1 (Batch Settings)
> F3 (CC Settings)

Range

When CSI-RS Periodicity T is 10: 0 to 9

When CSI-RS Periodicity T is 5: 0 to 4

Default

CC #0,1,2,3,4 0

3.12 Batch Measurement Results

Batch measurement is performed as below.

Procedure

1. Sets the parameters for Batch measurement.

 3.11 Setting Batch Measurement

2. Starts Batch measurement.

 3.1.3 Performing Measurement

3.12.1 Measurement results

The numeric results of Batch measurement are as below.

- (1) Band : Frequency Error

Displays the average frequency error of the CC included in Band.

- (2) Band : PDSCH EVM

Displays the average frequency error of the CC included in Band.

- (3) Band : Band Power

Displays the RF level of the Band. When MS269xA-004/104/078/178 or MS2830A-078 is not installed, no measurement results are displayed. When MS269xA-004/104/078/178 or MS2830A-078 is installed, the measurement result of 125 MHz bandwidth is displayed.

- (4) Band : RS Power

Displays the average RS power value of the CC included in Band.

- (5) Band : OSTP

Displays the average OSTP of the CC included in Band.

- (6) Band : OBW (Cont.CA)

Displays the OBW when Band Settings : Contiguous Mode is On. When the measurement bandwidth exceeds the analysis bandwidth, no measurement results are displayed.

- (7) Band : ACLR UTRA

Displays the ACLR UTRA. When the measurement bandwidth exceeds the analysis bandwidth, no measurement results are displayed.

(8) Band : ACLR E-UTRA

Displays the ACLR E-UTRA. When the measurement bandwidth exceeds the analysis bandwidth, no measurement results are displayed.

(9) Band : OBUE Margin

Displays the OBUE worst peak level relative to the standard template. When the measurement bandwidth exceeds the analysis bandwidth, no measurement results are displayed.

(10) Band : OBUE Peak Absolute Level

Displays the OBUE worst peak absolute level. When the measurement bandwidth exceeds the analysis bandwidth, no measurement results are displayed.

(11) Band : OBUE Peak Frequency

Displays the OBUE worst peak frequency. When the measurement bandwidth exceeds the analysis bandwidth, no measurement results are displayed.

(12) CC : Frequency Error

Displays the average frequency error of the CC.

(13) CC : PDSCH EVM

Displays the average PDSCH EVM of the CC.

(14) CC : CC Power

Displays the average RF level of the CC.

(15) CC : RS Power

Displays the RS power value of the CC.

(16) CC : OSTP

Displays the OSTP of the CC

(17) CC : Time Offset

Displays the time difference between the CCs in the band. The reference is the CC with the smallest number in the band.

(18) Band : OBW (CC)

Displays the OBW of the CC when Band Settings : Contiguous Mode is Off. When the measurement bandwidth exceeds the analysis bandwidth, no measurement results are displayed.

3.13 Spectrum Measurement

3.13.1 Adjacent Channel Leakage Power Measurement (ACP)

This calls the ACP function of the Signal Analyzer or Spectrum Analyzer functions. The Carrier Frequency, Input Level, Offset, Offset Value, Pre-Amp and Trigger settings are handed over automatically to the relevant parameter. “Recalling parameters” of the *MS2690A/MS2691A/MS2692A Signal Analyzer Operation Manual (Mainframe Operation)* or *MS2830A Signal Analyzer Operation Manual (Mainframe Operation)* cannot be executed when this function is being recalled.

ACP (FFT)

■ Summary

The ACP function of the Signal Analyzer function is called, and the adjacent channel leakage power is measured according to the handed over parameter settings. This function is only enabled when Channel Bandwidth is set to 1.4, 3, and 5 MHz.

ACP (Swept)

■ Summary

The ACP function of the Spectrum Analyzer function is called, and the adjacent channel leakage power is measured according to the handed over parameter settings.

3.13.2 Channel Power Measurement (Channel Power)

This calls the Channel Power function of the Signal Analyzer or Spectrum Analyzer functions. The Carrier Frequency, Input Level, Offset, Offset Value, Pre-Amp and Trigger settings are handed over automatically to the relevant parameter. “Recalling parameters” of the *MS2690A/MS2691A/MS2692A Signal Analyzer Operation Manual (Mainframe Operation)* or *MS2830A Signal Analyzer Operation Manual (Mainframe Operation)* cannot be executed when this function is being recalled.

Channel Power (FFT)

■ Summary

The Channel Power function of the Signal Analyzer function is called, and the channel power is measured according to the handed over parameter settings.

Channel Power (Swept)

■ Summary

The Channel Power function of the Spectrum Analyzer function is called, and the channel power is measured according to the handed over parameter settings.

3.13.3 Occupied Bandwidth Measurement (OBW)

This calls the OBW function of the Signal Analyzer or Spectrum Analyzer functions. The Carrier Frequency, Input Level, Offset, Offset Value, Pre-Amp and Trigger settings are handed over automatically to the relevant parameter. “Recalling parameters” of the *MS2690A/MS2691A/MS2692A Signal Analyzer Operation Manual (Mainframe Operation)* or *MS2830A Signal Analyzer Operation Manual (Mainframe Operation)* cannot be executed when this function is being recalled.

OBW (FFT)

■ Summary

The OBW function of the Signal Analyzer function is called, and the occupied bandwidth is measured according to the handed over parameter settings.

OBW (Swept)

■ Summary

The OBW function of the Spectrum Analyzer function is called, and the occupied bandwidth is measured according to the handed over parameter settings.

3.13.4 Spectrum Emission Mask Measurement (SEM)

This calls the Spectrum Emission Mask function of the Spectrum Analyzer function. The Carrier Frequency, Input Level, Offset, Offset Value, Pre-Amp and Trigger settings are handed over automatically to the relevant parameter. “Recalling parameters” of the *MS2690A/MS2691A/MS2692A Signal Analyzer Operation Manual (Mainframe Operation)* or *MS2830A Signal Analyzer Operation Manual (Mainframe Operation)* cannot be executed when this function is being recalled.

Spectrum Emission Mask (Swept)

■ Summary

The Spectrum Emission Mask function of the Spectrum Analyzer function is called, and the spectrum emission mask is measured according to the handed over parameter settings.



3.13.5 Advanced Settings

This function configures settings related to spectrum measurement.

Coupled Ref & ATT in Swept & FTT

This sets whether or not to handover the Reference Level and ATT settings between each spectrum measurement function.

Procedure

 >  (Advanced Settings) >

 (Coupled Ref & ATT in Swept & FTT)

Options On, Off

Default Off

Chapter 4 Digitizing and Replaying

This chapter describes how to set up the method for capturing input signals, how to save captured signals in a file as digitized data, and how to use the saved digitized data to reproduce measurements.

4.1	Digitize function.....	4-2
4.1.1	Loading IQ Data	4-2
4.1.2	Saving IQ Data	4-4
4.1.3	Format of data information file.....	4-5
4.1.4	Format of data file.....	4-7
4.2	Replay Function	4-8
4.2.1	Starting Replay Function	4-8
4.2.2	Display During Replay Function Execution ...	4-8
4.2.3	Restrictions When Executing the Replay Function	4-9
4.2.4	Characteristics of Replayable IQ Data Files .	4-9
4.2.5	Stopping Replay	4-9

4.1 Digitize function

4.1.1 Loading IQ Data

There are two modes for setting the method for determining the signal capturing interval.

Auto

The data necessary to measure five frames for each measurement is always captured.

Manual

In this mode, the number of frames measured for each measurement can be specified. Specify the number of frames for Capture Time Length. The frames in the interval specified for Capture Time Length must always be continuous.

The analysis interval for one measurement is the time it takes for five frames, starting at the beginning of a frame. If Capture Mode is set to Auto and Storage Mode is set to Average or Average & Max to average the results, the analysis interval is not continuous. If Capture Mode is set to Manual, the results can be averaged over a continuous interval.

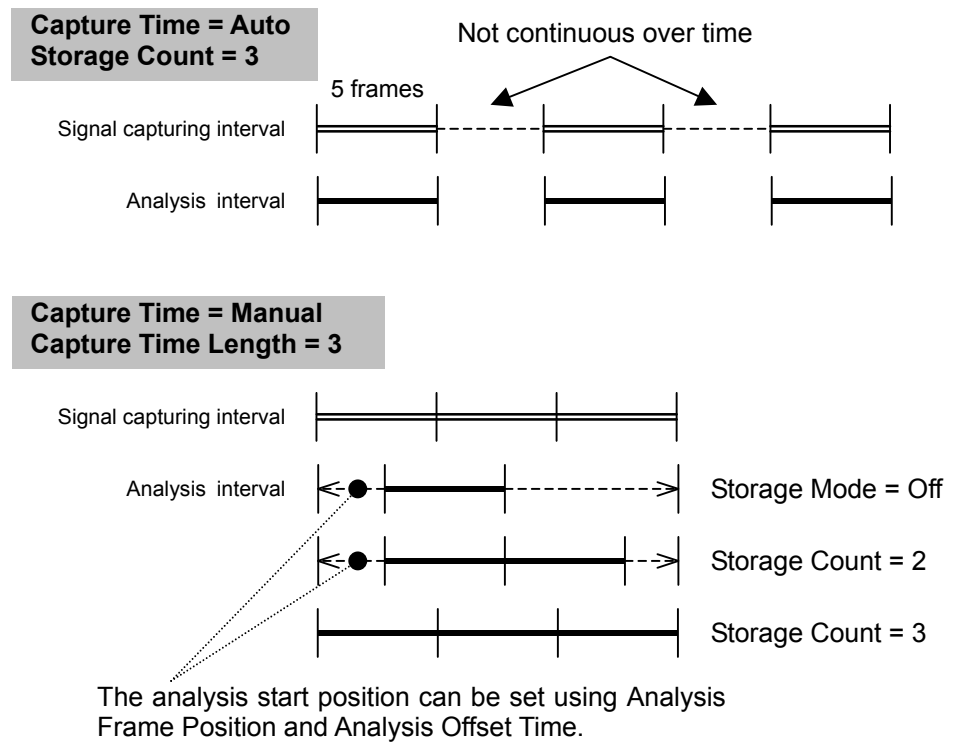

Figure 4.1.1-1 Differences in the signal capturing interval and analysis interval due to Capture Time

Figure 4.1.1-1 shows the relationship between the signal capturing interval and analysis interval for different Capture Time settings. The scale of the figure is based on the length of one measurement, which is equivalent to five frames.*

*: The actual amount of time it takes to capture an input signal is slightly longer than the value specified for Capture Time Length because internal processing such as frame synchronization processing is performed.

When measuring ACP, Channel Power, and OBW using the Replay function, save the IQ data in the Manual mode.

Capture Time

Sets the method for determining the signal capturing interval.

If Capture Time Length is specified, the Manual mode is automatically used.

Procedure

 > Capture (F7) > Capture Time (F1)

Options Auto, Manual
Default Auto

Capture Time Length

Sets the signal capturing time.

If Capture Time is set to Auto, Capture Time Length is automatically changed to five frames.

Procedure

 > Capture (F7) > Capture Time Length (F2)

Range 5 to 150 frame
Default 5 frame

4.1.2 Saving IQ Data

After a measurement, captured signals can be saved to an external device file in the IQ data format.

Procedure

1. Press **Capture** (F7) on the main function menu.
2. Press **Save Captured Data** (F3).
3. Press **Device** (F1) on the **Save Captured Data** function menu to select a data file for saving the IQ data.
4. Press **File Name** (F2) to set the file name.
5. Press **Exec Digitize** (F7) to save.

When save processing is executed, the following files are created.

- “[File Name].dgz” Data file (binary format)
- “[File Name].xml” Data information file (XML format)

The IQ data row is saved to the data file. The information on the saved data is saved to the data information file.

If the file name is not specified, a file name with the following format is used: Digitize*date_consecutive-number*

Here, *consecutive-number* is a value in the range from 000 to 999.

Files are saved to the following directory of the target drive specified using **Device** (F1).

\Anritsu Corporation\Signal Analyzer\User Data\Digitized
Data\LTETDD Downlink

Up to 1000 files can be made within the folder.

4.1.3 Format of data information file

The information on the saved IQ data is recorded in the data information file. Table 4.1.3-1 shows the details of the recorded parameters.

Table 4.1.3-1 Format of data information file

Item	Explanation
CaptureDate	Day/Month/Year of the captured data in the “DD/MM/YYYY” format.
CaptureTime	Data captured time in “HH/MM/SS” format
FileName	Data file name
Format	Data format, fixed to “Float”
CaptureSample	Number of samples of the recorded data [Sample]
Condition	Error status of the recorded data “Normal”: Normal status “OverLoad”: Level over
TriggerPosition	Trigger occurrence position [Sample] The start point of the recorded data is 0.
CenterFrequency	Center frequency [Hz]
SpanFrequency	Frequency span [Hz]
SamplingClock	Sampling rate [Hz]
PreselectorBandMode	Frequency band switch mode. “Normal”: Normal mode (fixed)
ReferenceLevel	Reference level [dBm] Note that this value does not include the reference level offset.
AttenuatorLevel	Attenuator value [dB]
InternalGain	Internal gain value [dB] This is an internal parameter.
PreAmp	Value of the gain (in dB) due to the 6 GHz preamp
IQReverse	IQ reverse setting, fixed to “Normal”
TriggerSwitch	Trigger On/Off setting “FreeRun”: Trigger is not used “Triggered”: Trigger is used

Table 4.1.3-1 Formatting the data information file (Cont'd)

Item	Explanation
TriggerSource	Trigger source “External”: External trigger “SGMarker”: SG marker trigger
TriggerLevel	Trigger level [dBm] Note that this value does not include the reference level offset. It is in dBm units, even if the scale mode is Lin.
TriggerDelay	Trigger delay time [s] It is the relative time from the trigger input position to the start point of the recorded data.
IQReference0dBm	Reference IQ amplitude that indicates 0 dBm Fixed to “1”.
ExternalReferenceDisp	Reference signal information “Ref.Int”: Internal reference signal “Ref.Ext”: External reference signal “Ref.Int Unlock”: Internal reference signal is unlocked. “Ref.Ext Unlock”: External reference signal is unlocked.
Correction Factor	Value of correction by the Correction function (in dB) Correction Factor is added to the IQ data in data files. This item is 0.000 if the Correction function is set to Off.
Terminal	Signal input terminal “RF”: RF terminal
ReferencePosition	0-second reference position Indicates the 0-second reference position using the digitized data point position. During Replay function execution, the reference position is displayed as 0 s.
Trigger Slope	Edge where the trigger is generated (rise or fall). “Rise”: Rising edge “Fall”: Falling edge

4.1.4 Format of data file

The data file is created in binary format. From the beginning of the file, I-phase data and Q-phase data are recorded by 4 bytes. The I-phase data and Q-phase data are recorded as a float type (IEEE real*4).

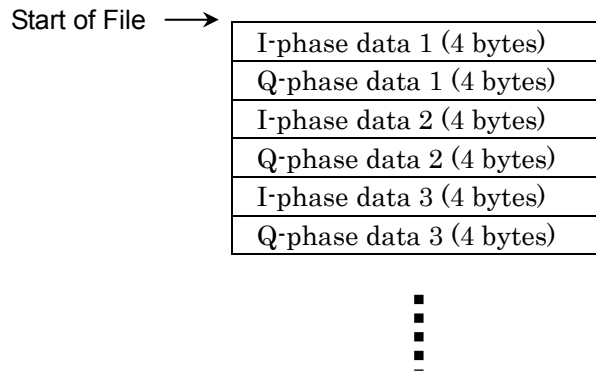

Figure 4.1.4-1 Format of data file

The IQ data can be converted to power based on the following formula:

$$P = 10 \log_{10}(I^2 + Q^2)$$

where

P : Power [dBm]

I : I-phase data

Q : Q-phase data

4.2 Replay Function

The Replay function enables the saved IQ data to be reanalyzed.

4.2.1 Starting Replay Function

Start the Replay function using the following procedure:

Procedure

1. Press **Capture** (F7) on the main function menu.
2. Press **Replay** (F4) on the Capture function menu.
3. Press **Device** (F1) on the Replay function menu and select the drive in which the target file is stored.
4. Press (F2) (**Application**), and then select the name of the application used to save the replay target file.
5. Press **Select File** (F7) to display a file selection dialog. The Replay function starts after selecting a file. Then, **Replaying** is displayed on the screen.

Note:

- 1 This function is executed only for an IQ data file whose sampling rate is 50 MHz.
- 2 Once Replay starts, the settings are initialized except for the parameters specified in Table 4.1.3-1.

4.2.2 Display During Replay Function Execution

Replay Error Info. is displayed if the target IQ data file meets the following conditions:

- Frequency reference is Unlocked when IQ data is saved.
- Level Over occurs when IQ data is saved

4.2.3 Restrictions When Executing the Replay Function

The functions that are restricted during a replay are shown in Table 4.2.3-1.

Table 4.2.3-1 Functions Restricted During Replay

Function
Center Frequency
Input Level
Pre Amp
Trigger Switch
Trigger Source
Trigger Slope
Trigger Delay
Continuous Measurement
Single Measurement
Capture Time Auto/Manual
Capture Time Length

4.2.4 Characteristics of Replayable IQ Data Files

The characteristics of IQ data files for which replay analysis is available are shown in Table 4.2.4-1.

Table 4.2.4-1 Replayable IQ data files

Item	Value
Format	I, Q (32-bit Float Binary format)
Sampling rate	50 MHz
Number of samples	Equivalent to one frame or more Modulation Analysis: 3,100,000 or more ACP, OBW, and Channel Power: 3,230,000 or more

4.2.5 Stopping Replay

Stop the Replay function using the following procedure:

Procedure

1. Press **Capture** (F7) on the main function menu.
2. Press **Stop Replaying** (F5) to stop the Replay function.

Chapter 5 Performance Test

This chapter describes measurement devices, setup methods, and performance test procedures required for performing performance tests as preventive maintenance.

- 5.1 Overview of Performance Test 5-2
 - 5.1.1 Performance test 5-2
- 5.2 Performance Test Items 5-3
 - 5.2.1 Testing methods 5-3



5.1 Overview of Performance Test

5.1.1 Performance test

Performance tests are performed as part of preventive maintenance in order to prevent the performance degradation before it occurs.

Use performance tests when required for acceptance inspection, routine inspection and performance verification after repairs. Perform items deemed critical at regular intervals as preventive maintenance. Perform the following performance tests for acceptance inspection, routine inspection and performance verification after repairs.

- Carrier frequency accuracy
- Residual EVM

Perform items deemed critical at regular intervals as preventive maintenance. A recommended cycle for routine tests of once or twice a year is desirable.

If items that do not meet the required level are detected during performance testing, contact an Anritsu Service and Sales office. Contact information can be found on the last page of the printed version of this manual, and is available in a separate file on the CD version.

5.2 Performance Test Items

Warm up the subject testing device and measuring instruments for at least 30 minutes except where directed, in order to stabilize them sufficiently before running performance tests. Demonstrating maximum measurement accuracy requires, in addition to the above, conducting performance tests under ambient temperatures, little AC power supply voltage fluctuations, as well as the absence of noise, vibrations, dust, humidity or other problems.

5.2.1 Testing methods

- (1) Test target standards
 - Carrier frequency accuracy
 - Residual EVM

- (2) Measuring instrument for tests
 - Vector signal generator
 - Frequency standard device Unnecessary if signal source has sufficient frequency accuracy
 - Power meter Unnecessary if signal source has sufficient transmitter power accuracy

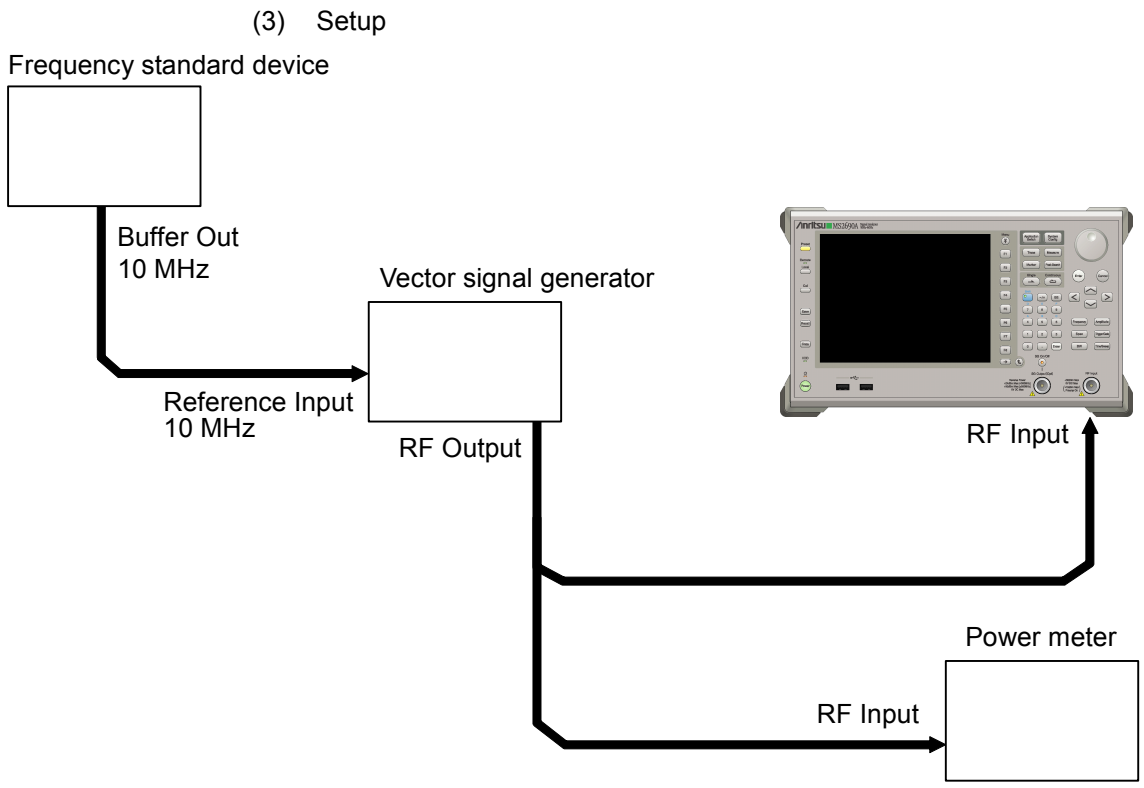

















Figure 5.2.1-1 Performance test

(4) Test procedure

(a) Signal source adjustment



1. Input the 10-MHz reference signal output from the frequency standard device into the Reference Input connector of the vector signal generator.
2. Input the 10 MHz reference signal output from the signal generator to the Reference Input connector.
3. Output an LTE TDD Downlink modulation signal from the vector signal generator.
4. Input the vector signal generator output signal into the power meter and measure the power.

(b) Settings of the main unit

1. Turn On the power switch on the front panel then wait until the internal temperature stabilizes (approx. 1.5 hours after the temperature in the thermostatic bath stabilizes).
2. Press , then press the menu function key displaying the character string “LTE-TDD Downlink.”
3. Press .
4. Press  (Preset) to perform initialization.
5. Press .
6. Press  (SIGANA All) to perform calibration.
7. Press  (Close).
8. Press , enter the frequency output by the vector signal generator using the numeric keypad, then press .
9. Press , enter the power meter measurement result using the numeric keypad, then press .
10. Press  then press  (Storage) and press  (Mode) to choose Average using the cursor key or the rotary knob , then press .
11. Press  (Count), enter the measurement count, using the numeric keypad, then press .

12. Press  to perform measurement.

When measuring the carrier frequency accuracy, select **Auto** for **Reference Signal**. When measuring the residual vector error, select **Fixed to Internal**.

Press  (System Settings) after pressing  to display the System Settings screen. Select and set Reference Signal with cursor key, and then press  (Set).

13. Confirm whether the measured Frequency Error (carrier frequency accuracy) is within the specifications.
 14. Confirm whether the measured EVM (rms) (residual vector error) value is within the specifications.

(5) Test Result

Table 5.2.1-1 Carrier frequency accuracy

Frequency	Min. limit	Deviation (Hz)	Max. limit	Uncertainty	Pass/Fail
600 MHz	MS269xA -3 Hz		MS269xA +3 Hz	MS269xA ±1 Hz	
1500 MHz	MS2830A -3.5 Hz		MS2830A +3.5 Hz	MS2830A ±0.2 Hz	
2000 MHz	MS2830A-x78		MS2830A-078	MS2830A-078	
2700 MHz		-4 Hz			+4 Hz
4000 MHz 3600 MHz (MS2830A-040)	MS269xA -3 Hz		MS269xA +3 Hz	MS269xA ±1 Hz	
	MS2830A -8 Hz		MS2830A +8 Hz	MS2830A ±1.1 Hz	
	MS2830A-078 -8 Hz		MS2830A-078 +8 Hz	MS2830A-078 ±1.1 Hz	

Table 5.2.1-2 Residual vector error

Frequency	Measured value [% (rms)]	Max. limit	Uncertainty	Pass/Fail
600 MHz		MS269xA 1.0 % (rms)	MS269xA 0.1 % (rms)	
1500 MHz		MS269xA-x78	MS269xA-x78	
2000 MHz				1.3 % (rms)
2700 MHz		MS2830A 1.3 % (rms)	MS2830A 0.2 % (rms)	
4000 MHz 3600 MHz (MS2830A-040)		MS2830A-078 1.3 % (rms)	MS2830A-078 0.1 % (rms)	

Chapter 6 Other Functions

This chapter describes other functions of this application.

6.1	Selecting Other Functions	6-2
6.2	Setting Title	6-2
6.3	Erasing Warmup Message	6-2

6.1 Selecting Other Functions

Pressing  (Accessory) on the main function menu displays the Accessory function menu.





Table 6.1-1 Accessory function menu

Function Keys	Menu Display	Function
F1	Title	Sets the title character string.
F2	Title (On/Off)	Displays (On) or hides (Off) the title character string.
F4	Erase Warm Up Message	Erases the warmup message display.

6.2 Setting Title

A title of up to 32 characters can be displayed on the screen. (Character strings of up to 17 characters can be displayed on a function menu. The maximum number of characters to be displayed on the top of the function menu varies according to character string.)



<Procedure>

1. Press  (Accessory) on the main function menu.
2. Press  (Title) to display the character string input screen. Select a character using the rotary knob, and enter it by pressing . Enter the title by repeating this operation. When the title is entered, press  (Set).
3. Press  (Title) and then select “Off” to hide the title.

6.3 Erasing Warmup Message

The warmup message , which is displayed upon power-on and indicates that the level and frequency are not stable, can be deleted.

<Procedure>

1. Press  (Accessory) on the main function menu.
2. Press  (Erase Warm Up Message) to erase the warmup message.

References are to page numbers.

Symbol and Numbers

1

1st Local Output connector..... 2-7

A

AC inlet..... 2-10

Accessory..... 6-2

ACLR..... 3-99

ACLR E-UTRA 3-132

ACLR UTRA 3-131

ACP 3-9, 3-134

Adjacent Channel Leakage Power 3-134

Amplitude 3-12, 3-14, 3-57

AMPLitude 3-14

Analysis Time 3-23, 3-25

Application key 2-7

Application Switch 2-12

Auto Range 3-14

AUX connector..... 2-9

B

Band Power..... 3-131

Bottom Graph Marker Number..... 3-64, 3-90

Bottom Graph Select..... 3-65

Bottom Graph Symbol Number..... 3-53

Buffer Out Connector..... 2-9

C

Cal key 2-3

Calibration..... 2-3

Cancel key..... 2-6

Carrier Frequency..... 3-12, 3-101

CC Power 3-132

Cell ID 3-109

Channel Bandwidth..... 3-17, 3-29, 3-56, 3-60, 3-63, 3-64, 3-106

Channel Estimation 3-43, 3-113

Channel Power 3-9, 3-67

Common Setting..... 3-17

Constellation..... 3-52

Constellation Marker Number 3-63

Constellation Select..... 3-63

Constellation Symbol Number 3-52

Contiguous Mode..... 3-103

Continuous..... 3-10

Copy key..... 2-3

Count..... 3-48

Coupled Ref & ATT in Swept & FTT..... 3-136

CRS Antenna Port 3-111

CRS Number of Antenna Ports..... 3-110

CRS Power Boosting..... 3-109

CSI-RS Antenna Port 3-111

CSI-RS Configuration 3-129

CSI-RS Number of Antenna Ports..... 3-110

CSI-RS On/Off 3-128

CSI-RS Periodicity T 3-129

CSI-RS Subframe Offset 3-130

Cursor key..... 2-6

D

Detail Settings..... 3-45

DwPTS 3-113

E

Enter key..... 2-6

Erase Warm Up Message..... 6-2

Ethernet connector 2-10

Ethernet: 2-4

EVM vs RB..... 3-62

EVM vs Subcarrier 3-49, 3-53

EVM vs Subcarrier View..... 3-53

EVM vs Symbol 3-49, 3-55

EVM vs Symbol View 3-55

EVM Window Length 3-28, 3-29, 3-112

Extended Freq Lock Range..... 3-45

F

Frequency 3-12

Frequency Band..... 3-105

Frequency Error 3-51, 3-87, 3-131, 3-132

Frequency Offset 3-105

Front panel 2-2

Function keys..... 2-4

Index

Function menu 3-8

G

Gap 3-75

GPIB 2-4, 2-9

GPIB connector 2-9

Graph Select 3-89

Graph View 3-53, 3-55, 3-61

H

Hard disk access lamp 2-3

HDD slot 2-10

I

IF Out connector 2-9

IF output connector 2-10

Input Level 3-101

L

Limiter Mode 3-81

Limiter Mode ATT 3-81

Limiter Mode Offset 3-82

Limiter Mode Offset Value 3-82

Load Application Select 2-12

Load Standard setting 3-79

Local key 2-4

M

Main function keys 2-5

Marker 3-63, 3-89

Measure 3-7

Measurement Filter Type 3-45, 3-114

Measurement Interval 3-25, 3-97

Measurement Interval for Unwanted Emissions
..... 3-98

Measurement Item 3-100, 3-104

Measurement Parameter 3-6

mi 3-39

Modulation Analysis 3-9, 3-98

Modulation control key 2-7

Monitor Out connector 2-10

N

Next Peak 3-90

Noise Calculate 3-83

Noise Correction 3-73

Noise Correction Mode 3-82

Number of PDCCH Symbols 3-125

Number of PDCCHs 3-128

Numeric keypad 2-6

O

OBUE 3-99

OBUE Margin 3-132

OBUE Peak Absolute Level 3-132

OBUE Peak Frequency 3-132

OBUE Standard 3-103

OBUE Standard Additional 3-104

OBW 3-9, 3-99, 3-135

OBW (CC) 3-133

OBW (Cont.CA) 3-131

Occupied Bandwidth 3-135

Off Power Limit 3-78

Offset 3-13, 3-102

Offset Value 3-13, 3-102

OSTP 3-131, 3-132

P

Page Number 3-66, 3-69

PBCH On/Off 3-114

PBCH Power Auto/Manual 3-115

PBCH Power Boosting 3-115

PCFICH On/Off 3-120

PCFICH Power Auto/Manual 3-121

PCFICH Power Boosting 3-121

PDCCH Format 3-127

PDCCH Mapping 3-127

PDCCH On/Off 3-119

PDCCH Power Auto/Manual 3-119

PDCCH Power Boosting 3-120

PDSCH EVM 3-131, 3-132

PDSCH Modulation Scheme 3-26, 3-112

PDSCH Power Auto/Manual 3-123

PDSCH Power Boosting 3-124

Peak Search (Margin) 3-90

PHICH - Ng 3-124

PHICH Duration 3-125

PHICH On/Off 3-122

PHICH Power Auto/Manual 3-122

- PHICH Power Boosting 3-123
- Power Boosting 3-21
- Power Switch 2-3
- Power vs RB..... 3-49
- Power vs RB View 3-61
- Power vs Time 3-9
- Pre-Amp 3-14, 3-102
- Pre-Amp Mode 3-73
- Preset key 2-4
- P-SS On/Off..... 3-116
- P-SS Power Auto/Manual 3-116
- P-SS Power Boosting..... 3-117
- R**
- Rear panel..... 2-8
- Recall key..... 2-3
- Ref Input connector 2-9
- reference frequency signal..... 2-9
- Reference Signal..... 3-20, 3-21, 3-22, 3-91
- Remote lamp 2-4
- Resource Block Number..... 3-60
- RF Input connector 2-6
- RF Output connector..... 2-7
- RF Output Control key 2-6
- Rotary knob 2-6
- RS EVM 3-94
- RS Freq 3-94
- RS Phase..... 3-94
- RS Power..... 3-94, 3-131, 3-132
- RS Timing Offset..... 3-94
- S**
- SA Trigger Input connector..... 2-10
- Save key 2-3
- Scale 3-51
- Select Mask..... 3-75
- SEM..... 3-136
- SG Trigger Input connector 2-10
- Shift key..... 2-6
- Single 3-10
- Smoothing..... 3-74
- Smoothing Length..... 3-74
- Smoothing Range 3-74
- Special Subframe Configuration 3-108
- Spectral Flatness..... 3-49, 3-57
- Spectral Flatness Type..... 3-57
- Spectrum Emission Mask 3-9, 3-136
- S-SS On/Off..... 3-117
- S-SS Power Auto/Manual..... 3-118
- S-SS Power Boosting..... 3-118
- Start Time..... 3-76
- Starting OFDM Symbol Number 3-97
- Starting Subframe Number..... 3-23, 3-96
- Stop Time 3-77
- Storage 3-48
- Storage Count..... 3-86, 3-95
- Storage Count for Unwanted Emissions..... 3-96
- Storage Mode 3-86, 3-95
- Storage Mode for Unwanted Emissions..... 3-95
- Subcarrier Number 3-56
- Subframe Number..... 3-59
- Summary..... 3-49, 3-66
- Sweep Status Out connector..... 2-9
- Synchronization Mode..... 3-108
- T**
- Test Model..... 3-17, 3-106
- Test Model Starting Frame Type..... 3-44, 3-107
- Test Model Summary 3-49, 3-69
- Test Model Version 3-17
- Time Offset..... 3-132
- Time Reference 3-78
- Title 6-2
- Title (On/Off) 6-2
- Top Graph Marker Number..... 3-89
- Top Graph Marker to Fail..... 3-90
- Top Graph Marker to Transient 3-90
- Total EVM & Constellation Composite 3-27
- Trace Mode..... 3-49
- Trigger Delay 3-16
- Trigger Input connector 2-9
- trigger signal..... 2-9, 2-11
- Trigger Slope..... 3-16
- Trigger Source..... 3-15
- Trigger Switch 3-15
- U**
- Uplink-downlink Configuration 3-107

Index

USB connector 2-7
 Type A..... 2-10
 Type B..... 2-9

W

Wide Dynamic Range 3-72